

ARTESYN LCC600 SERIES

600 Watts Conduction Mounting



PRODUCT DESCRIPTION

Advanced Energy's Artesyn LCC600 series of fully enclosed conduction cooled AC-DC power supplies comprises four models, offering main output voltages of 12 V, 28 V, 36 V or 48 V. Each model also provides a 5 V standby output that can supply up to 1.5 amps. Rated at 600 watts, these power supplies incorporate a thermal baseplate and are capable of delivering full output power over a wide operating temperature range of -40 to 85°C. For maximum applications flexibility, the main output is adjustable. The 48 V model, for example, can be adjusted from 44 to 54 V and has a maximum current rating of 12.5 amps.

SPECIAL FEATURES

- 600W full power at elevated temperatures
- Wide operating temperature range (-40 °C to 85 °C baseplate)
- Adjustable output
- Remote output on/off
- AC_OK; DC_OK signals
- 5V standby voltage
- Active current share
- Conduction-cooled / fanless
- I²C / PMBus™
- Medical and ITE safety
- Suited for BF-type applications
- Active power factor correction
- Optional IP65 variant
- Optional 277Vac input variant
- OR-ing FET

COMPLIANCE

- EMI Class B
- EN61000 Immunity

SAFETY

- UL+CSA 62368-1 2nd Ed. ANSI ES60601-1³ ; UL 8750⁵ and CSA-C22.2 No. 250.13⁵
- 62368-1 2nd Ed + 60601-1 2nd Ed and EN61347-1;2-13
- China CCC
- CB Scheme IEC 62368-1 IEC 60950-1 IEC 61347-1; 2-13⁵ IEC 60601-1
- CE Mark
- UKCA Mark

AT A GLANCE

Total Power

600 Watts

Input Voltage

90 to 264 Vac

of Outputs

Single



MODEL NUMBERS

Model ^{1,2}	Input Voltage	Output Voltage	Adjustment Range	Minimum Load	Maximum Load	Typical Efficiency ³	Stand-By Supply
LCC600-12U-9P	90-264Vac	12.0V	12V-15V	0A	50A	92.3%	5V@1.5A
LCC600-12U-4P	90-264Vac	12.0V	12V-15V	0A	50A	92.3%	5V@1.5A
LCC600-12H-9P	180-305Vac	12.0V	12V-15V	0A	50A	92.3%	5V@1.5A
LCC600-12H-4P	180-305Vac	12.0V	12V-15V	0A	50A	92.3%	5V@1.5A
LCC600-28U-9P24	90-264Vac	24.0V	24V-30V	0A	25A	93.0%	5V@1.5A
LCC600-28U-9P	90-264Vac	28.0V	24V-30V	0A	25A ⁴	93.5%	5V@1.5A
LCC600-28U-4P	90-264Vac	28.0V	24V-30V	0A	25A ⁴	93.5%	5V@1.5A
LCC600-28H-9P	180-305Vac	28.0V	24V-30V	0A	25A ⁴	93.5%	5V@1.5A
LCC600-28H-4P	180-305Vac	28.0V	24V-30V	0A	25A ⁴	93.5%	5V@1.5A
LCC600-36U-9P	90-264Vac	36.0V	32V-38V	0A	16.7A	92.0%	5V@1.5A
LCC600-36U-4P	90-264Vac	36.0V	32V-38V	0A	16.7A	92.0%	5V@1.5A
LCC600-36H-9P	180-305Vac	36.0V	32V-38V	0A	16.7A	92.0%	5V@1.5A
LCC600-36H-4P	180-305Vac	36.0V	32V-38V	0A	16.7A	92.0%	5V@1.5A
LCC600-48U-9P	90-264Vac	48.0V	44V-54V	0A	12.5A	93.0%	5V@1.5A
LCC600-48U-4P	90-264Vac	48.0V	44V-54V	0A	12.5A	93.0%	5V@1.5A
LCC600-48H-9P	180-305Vac	48.0V	44V-54V	0A	12.5A	93.0%	5V@1.5A
LCC600-48H-4P	180-305Vac	48.0V	44V-54V	0A	12.5A	93.0%	5V@1.5A
LCC600-48U-9P	90-264Vac	54.0V	44V-54V	0A	11.1A	93.0%	5V@1.5A
LCC600-48U-4PD ⁵	90-264Vac	54.0V	44V-54V	0A	11.1A	93.0%	5V@1.5A

Note 1- Change suffix "-9P" to "-4P" for IP65 rated enclosure with fly lead wires.

Change suffix "-4P" to "-4PR" for IP65 rated enclosure with right angle fly lead wires (applies to 28, 36, 48VDC)

Change suffix "-4P" to "-4PV" to omit control cable (applies to 28, 36, 48VDC).

Note 2- Add suffix "24" after "P" to designate output voltage factory set to 24V (only on 28V models like LCC60028H-4P24CC).

Add suffix "CC" for Constant Current setting (e.g. "-4PCC"; "-9PCC").

Note 3- Typical efficiency at high line, factory default voltage and full load.

Note 4- When Vout is adjusted down to 24 V, the supply can deliver 25 A max (600 W max). At 28 V default output setting, max lout is 21.43 A (600 W max).

Note 5- "D" suffix for 0-10Vdc analog external voltage dimming (11.1 A CC limit).

Options

None

ELECTRICAL SPECIFICATIONS

Absolute Maximum Ratings

Stress in excess of those listed in the “Absolute Maximum Ratings” may cause permanent damage to the power supply. These are stress ratings only and functional operation of the unit is not implied at these or any other conditions above those given in the operational sections of this TRN. Exposure to any absolute maximum rated condition for extended periods may adversely affect the power supply’s reliability.

Table 1. Absolute Maximum Ratings						
Parameter	Model	Symbol	Min	Typ	Max	Unit
Input Voltage AC continuous operation ¹	U Suffix	$V_{IN,AC}$	90	-	264	Vac
	H Suffix		180	-	305	Vac
Maximum Output Power	All models	$P_{O,max}$	-	-	600	W
Isolation Voltage(Qualification) Input to output (2X MOPP) Input to safety ground (1X MOPP) Outputs to safety ground (1X MOPP)	U Suffix		-	-	4000	Vac
			-	-	1500	Vac
			-	-	1500	Vac
Isolation Voltage(Qualification) Input to output Input to safety ground Outputs to safety ground	H Suffix		-	-	3000	Vac
			-	-	2000	Vac
			-	-	1500	Vac
Isolation Voltage(Production) Input to output (2X MOPP) Input to safety ground (1X MOPP) Outputs to safety ground (1X MOPP)	U Suffix		-	-	1800	Vac
			-	-	1800	Vac
			-	-	1500	Vac
Isolation Voltage(Production) Input to output Input to safety ground Outputs to safety ground	H Suffix		-	-	2642	Vdc
			-	-	2200	Vdc
			-	-	1500	Vac
Baseplate Operating Temperature	All models	$T_{BASEPLATE}$	-40	-	+85 ²	°C
Storage Temperature	All models	T_{STG}	-40	-	+85	°C
Humidity (non-condensing) Operating Non-operating	All models		10	-	95	%
	All models		10	-	95	%
Altitude Operating Non-operating	All models		-	-	16,402	feet
	All models		-	-	50,000	feet

Note 1 - U suffix - Safety rating: 100-240 Vac.

H suffix - Safety rating: 200-277 Vac.

Note 2 - With derating up to 95 °C, detail see page 44.

ELECTRICAL SPECIFICATIONS

Input Specifications

Table 2. Input Specifications							
Parameter		Condition	Symbol	Min	Typ	Max	Unit
Operating Input Voltage, AC	LCC600-12U LCC600-28U LCC600-36U LCC600-48U	All	$V_{IN,AC}$	90	115/230	264	Vac
	LCC600-12H LCC600-28H LCC600-36H LCC600-48H			180	230/277	305	
Operating Input Voltage, DC ¹	LCC600-12U LCC600-28U LCC600-36U LCC600-48U	All	$V_{IN,DC}$	127	-	374	Vdc
	LCC600-12H LCC600-28H LCC600-36H LCC600-48H			254	-	420	
Input AC Frequency		All	$f_{IN,AC}$	47	50/60	63 440 ²	Hz
Maximum Input Current	LCC600-12U LCC600-28U LCC600-36U LCC600-48U	$V_{IN,AC} = 90Vac$	$I_{IN,max}$	-	-	10	A
	LCC600-12H LCC600-28H LCC600-36H LCC600-48H	$V_{IN,AC} = 180Vac$		-	-	5	
No Load Input Current ($V_O = On, I_O = 0A$)	LCC600-12U LCC600-28U LCC600-36U LCC600-48U	$V_{IN,AC} = 90Vac$	$I_{IN,no-load}$	-	-	150	mA
	LCC600-12H LCC600-28H LCC600-36H LCC600-48H	$V_{IN,AC} = 180Vac$		-	-	250	

Note 1 - DC input rating not part of product's safety approval.
 Note 2 - Meets functional parameters.

ELECTRICAL SPECIFICATIONS

Input Specifications

Table 2. Input Specifications							
Parameter		Condition	Symbol	Min	Typ	Max	Unit
No Load Input Power ($V_o = 0V$, $I_o = 0A$)	LCC600-12U LCC600-28U LCC600-36U LCC600-48U	$V_{IN,AC} = 90Vac$	$P_{IN,no-load}$	-	-	6.0	W
	LCC600-12H LCC600-28H LCC600-36H LCC600-48H	$V_{IN,AC} = 180Vac$		-	-	5.0	
Harmonic Line Currents		All	THD	Per EN61000-3-2 Class A and Class C ³			
Power Factor		$I_o = I_{o,max}$ $V_{IN,AC} = 230Vac$ $f = 50/60Hz$	PF	-	0.99	-	
Startup Surge Current (Inrush) @ 25°C ⁴		All		-	-	25	A_{PK}
Input Fuse	LCC600-12U LCC600-28U LCC600-36U LCC600-48U	All		-	-	12.5	A
	LCC600-12H LCC600-28H LCC600-36H LCC600-48H			-	-	7	
Leakage Current to earth ground		U Suffix: 264Vac,60Hz ⁵ U Suffix: 264Vac,50Hz ⁶ H Suffix: 305Vac		-	115 387 200	200 500 3500	μA μA μA
PFC Switching Frequency		All	$f_{SW,PFC}$	-	74	-	kHz
Operating Efficiency @ 25°C	LCC600-12U LCC600-28U LCC600-36U LCC600-48U	$I_o = I_{o,max}$ $V_{IN,AC} = 230Vac$	η	-	92.3	-	%
	LCC600-12H LCC600-28H LCC600-36H LCC600-48H	$I_o = I_{o,max}$ $V_{IN,AC} = 277Vac$		-	93.5	-	
				-	92.0	-	
				-	93.0	-	
				-	92.3	-	
				-	93.5	-	
				-	92.0	-	
				-	93.0	-	

Note 3 - Meets Class C $\geq 50\%$ load.

Note 4 - Measured per standard test conditions.

Note 5 - Per ANSI/ES60601; 264 Vac split-phase/ 60Hz

Note 6 - Per IEC60601; 264 Vac/ 50Hz

ELECTRICAL SPECIFICATIONS

Output Specifications

Table 3. Output Specifications							
Parameter		Condition	Symbol	Min	Typ	Max	Unit
Factory Set Voltage	LCC600-12U LCC600-12H	$I_o = 50\%$ rated load	V_o	11.94	12.00	12.06	Vdc
	LCC600-28U LCC600-28H			27.86	28.00	28.14	
	LCC600-36U LCC600-36H			35.82	36.00	36.18	
	LCC600-48U LCC600-48H			47.76	48.00	48.24	
Output Voltage Adjustment Range	LCC600-12U LCC600-12H	$I_o = 0A$	V_o	12.00	12.00	15.00	Vdc
	LCC600-28U LCC600-28H			24.00	28.00	30.00	
	LCC600-36U LCC600-36H			32.00	36.00	38.00	
	LCC600-48U LCC600-48H			44.00	48.00	54.00	
Output Regulation	LCC600-12U LCC600-12H	Inclusive of set-point, temperature change, warm-up drift and dynamic load	V_o	11.76	12.00	12.24	Vdc
	LCC600-28U LCC600-28H			27.44	28.00	28.56	
	LCC600-36U LCC600-36H			35.28	36.00	36.72	
	LCC600-48U LCC600-48H			47.04	48.00	48.96	
	All models		V_{SB}	4.75	5.00	5.25	
Output Ripple, pk-pk	LCC600-12U LCC600-12H	Measure with a 0.1 μ F ceramic capacitor in parallel with a 10 μ F tantalum capacitor, 0 to 20MHz bandwidth	V_o	-	-	120	mV _{PK-PK}
	LCC600-28U LCC600-28H			-	-	280	
	LCC600-36U LCC600-36H			-	-	360	
	LCC600-48U LCC600-48H			-	-	480	
	All models	V_{SB}	-	-	50		
Output dimming		By external voltage	-	0	-	10	Vdc
		By external resistance	-	0	-	100	kOhm

ELECTRICAL SPECIFICATIONS

Output Specifications

Table 3. Output Specifications							
Parameter		Condition	Symbol	Min	Typ	Max	Unit
Output Current	LCC600-12U LCC600-12H	All	I_o	0	-	50	A
	LCC600-28U LCC600-28H			0	-	21.5	
	LCC600-36U LCC600-36H			0	-	16.7	
	LCC600-48U LCC600-48H			0	-	12.5	
	All models		I_{SB}	0	-	1.5	
Output Power		All	P	0	-	600	W
Ripple Switching Frequency		All	f_{sw}	150	-	300	kHz
Baseplate temperature		All	T_A	90	95	98	°C
OTP level Hysteresis				15	33	-	°C
Quantity of Units in Parallel Operation		Main Output "ISHARE" connected	-	-	-	5	Units
V_o Load Capacitance		Start up	-	0	-	330	uF/A
V_o Dynamic Response ¹	Peak Deviation Settling Time	$I_{O,min} = 8.5W$ (15W for 12V) to 25% $I_{O,max}$ change, slew rate = 1A/us	$\pm\%V_o$ T_s	- -	- -	3 500	% uSec
	Peak Deviation Settling Time	$I_{O,min} = 8.5W$ (15W for 12V) to 50% $I_{O,max}$ change, slew rate = 1A/us	$\pm\%V_o$ T_s	- -	- -	5 500	% uSec
	Peak Deviation Settling Time	50% $I_{O,max}$ to $I_{O,max}$ change, slew rate = 1A/us	$\pm\%V_o$ T_s	- -	- -	3 500	% uSec
V_o Long Term Stability Max change over 24 hours		After thermal equilibrium (30 mins)	$\pm\%V_o$	-	-	2	%

Note 1 - Tested with minimum output capacitor of 330uF/A

ELECTRICAL SPECIFICATIONS

Output Specifications

Table 4. Output current with the output voltage level from minimum to maximum trimming					
Series	Nominal Output Voltage (V)	Output Voltage Trimming Range (V)	I _{out_max} (A)	P _{out_max} (W)	Lowest Voltage For CC mode application (V)
LCC600-12x-xx	12	12	50.00	600	10.8
		13	46.15	600	
		14	39.30	550	
		15	35.00	525	
LCC600-28x-xx	28	24	25.00	600	21.6
		25	24.00	600	
		26	23.08	600	
		27	22.22	600	
		28	21.42	600	
		29	20.70	600	
		30	20.00	600	
LCC600-36x-xx	36	32	16.70	534	28.8
		33	16.70	551	
		34	16.70	568	
		35	16.70	585	
		36	16.66	600	
		37	16.21	600	
		38	15.78	600	
LCC600-48x-xx	48	44	12.50	550	39.6
		45	12.50	563	
		46	12.50	575	
		47	12.50	588	
		48	12.50	600	
		49	12.25	600	
		50	12.00	600	
		51	11.76	600	
		52	11.53	600	
		53	11.32	600	
		54	11.11	600	

ELECTRICAL SPECIFICATIONS

System Timing Specifications

Table 5. Specifications					
Label	Parameter	Min	Typ	Max	Unit
T1	Delay from AC being applied to V_O being within regulation	-	1500	2500	mSec
T2	Delay from AC being applied to G_ACOK_C signal assertion (going Low)	200	450	1000	mSec
T3	V_O rise time, 0V to V_O in regulation	-	50	100	mSec
T4	Delay from V_O within regulation to G_DCOK_C signal assertion (going Low)	-	200	500	mSec
T5	Delay from AC loss to V_O falling out of regulation. V_O at nominal set point.	20	-	-	mSec
T6	Delay from AC loss to G_ACOK_C signal de-assertion (going High)	-	10	15	mSec
T7	Delay from G_DCOK_C signal de-assertion (going High) to V_O dropping to less than the output lower trimming range	1	9	-	mSec
T8	Delay from INH_EN going High to V_O being within regulation	-	112	1500	mSec
T9	Delay from INH_EN assertion (Pulled low) to G_DCOK_C signal going High.	-	1.2	3	mSec
T10	Delay from AC being applied to V_{SB} output being within regulation.	-	120	1000	mSec
T11	Delay from AC loss to V_{SB} going out of regulation. Last one to turn-off to guarantee other logic & control functionality	30	120	-	mSec

ELECTRICAL SPECIFICATIONS

System Timing Diagram

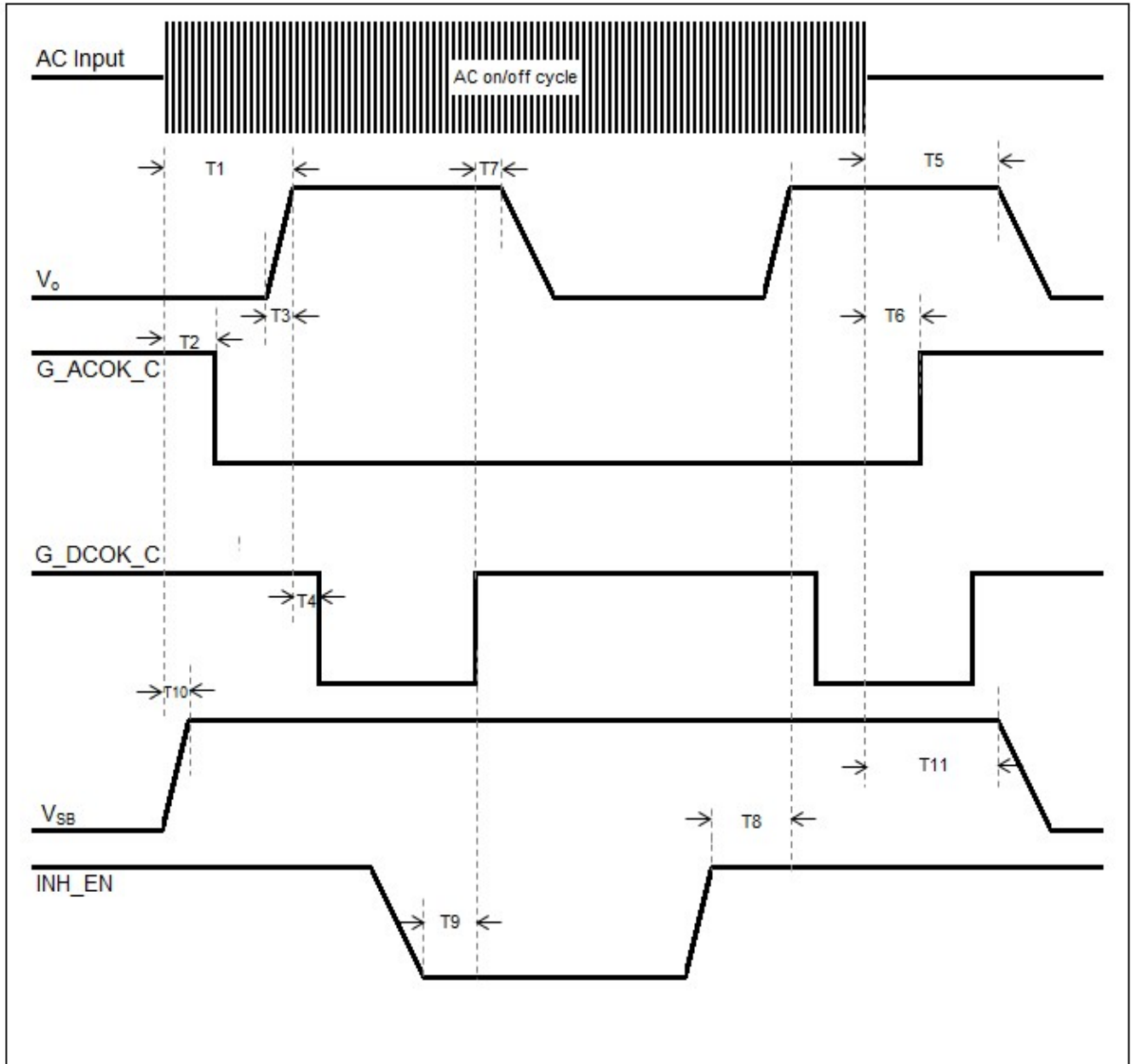

ELECTRICAL SPECIFICATIONS

LCC600-12U-9P Performance Curves

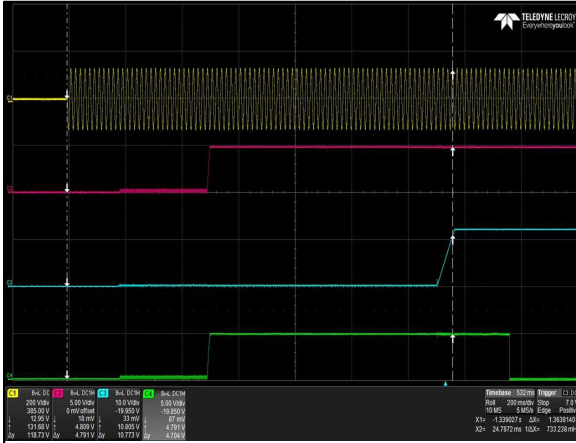

Figure 1: LCC600-12U-9P Turn-on delay via AC mains
 Vin = 90Vac Load: Io = 50A (12V), I_{SB} = 1.5A (5V)
 Ch 1: AC Mains Ch 2: V_{SB} Ch 3: V_O CH 4: G_DCOK_C

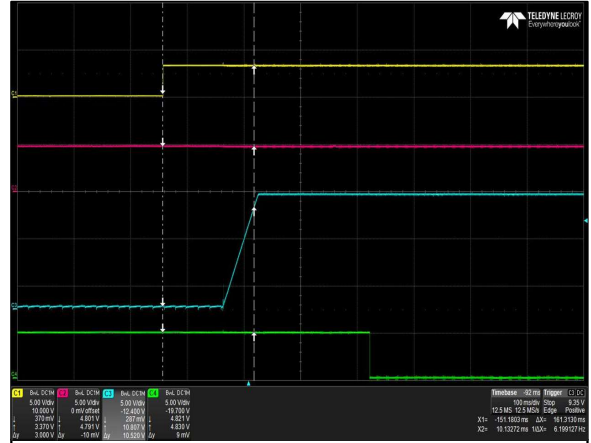

Figure 2: LCC600-12U-9P Turn-on delay via INH_EN
 Vin = 90Vac Load: Io = 50A (12V), I_{SB} = 1.5A (5V)
 Ch 1: INH_EN Ch 2: V_{SB} Ch 3: V_O CH 4: G_DCOK_C



Figure 3: LCC600-12U-9P Hold-up Time
 Vin = 90Vac / 63Hz / 0° Load: Io = 50A (12V), I_{SB} = 1.5A (5V)
 Ch 1: AC Mains Ch 2: V_{SB} Ch 3: V_O CH 4: G_DCOK_C

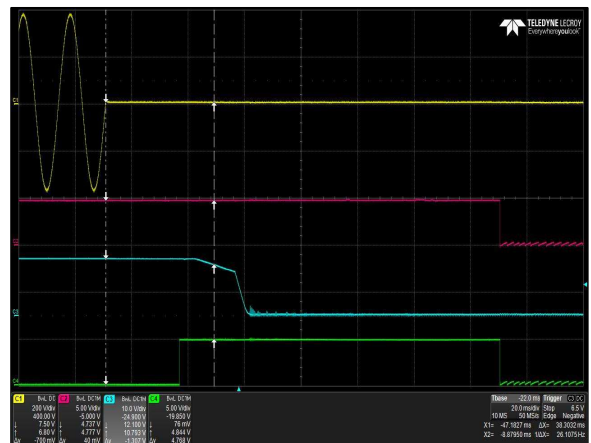

Figure 4: LCC600-12U-9P Hold-up Time
 Vin = 264Vac / 47Hz / 0° Load: Io = 50A (12V), I_{SB} = 1.5A (5V)
 Ch 1: AC Mains Ch 2: V_{SB} Ch 3: V_O CH 4: G_DCOK_C

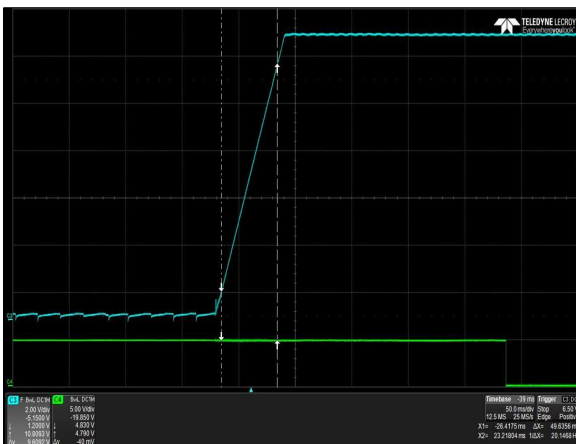

Figure 5: LCC600-12U-9P Output Startup Characteristic
 Vin = 90Vac Load: Io = 50A (12V), I_{SB} = 1.5A (5V)
 Ch 1: V_O Ch 2: G_DCOK_C

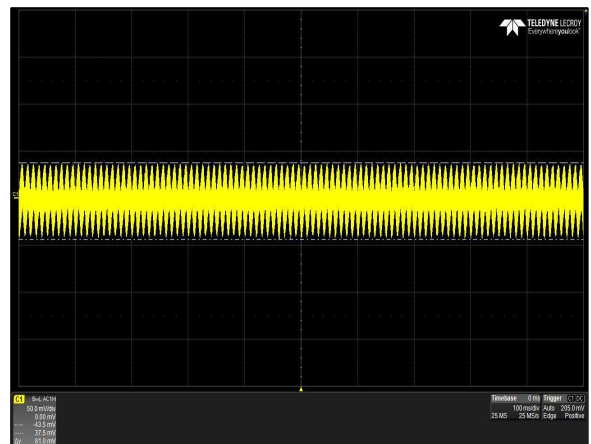

Figure 6: LCC600-12U-9P Ripple and Noise Measurement
 Vin = 90Vac Load: Io = 50A (12V), I_{SB} = 1.5A (5V)
 Ch 1: V_O

ELECTRICAL SPECIFICATIONS

LCC600-12U-9P Performance Curves

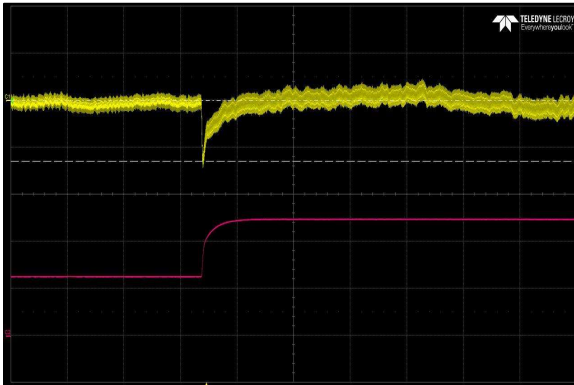

Figure 7: LCC600-12U-9P Transient Response - Vo Deviation
 50% to 100% load change 1A/uS slew rate Vin = 230Vac
 Ch 1: Vo Ch 2: Io

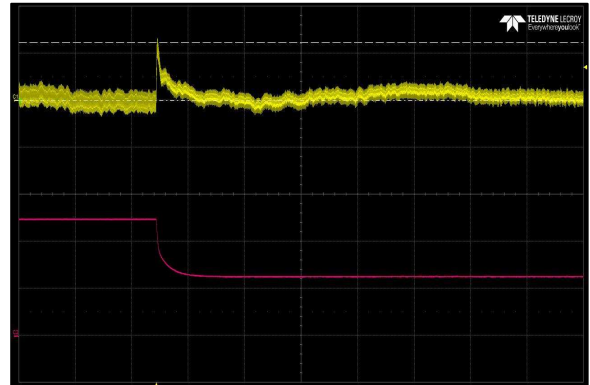

Figure 8: LCC600-12U-9P Transient Response - Vo Deviation
 100% to 50% load change 1A/uS slew rate Vin = 230Vac
 Ch 1: Vo Ch 2: Io

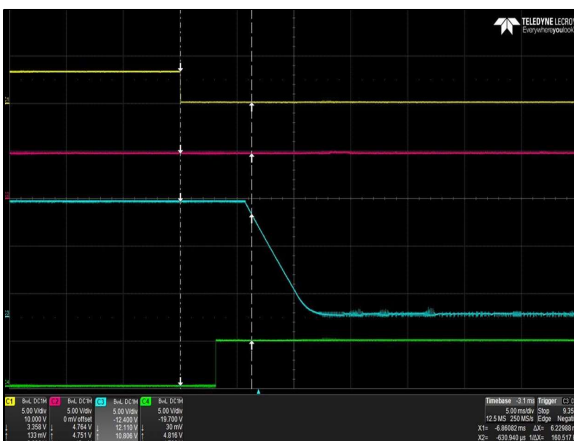

Figure 9: LCC600-12U-9P Turn Off Characteristic via INH_EN
 Load: Io = 50A (12V), Isb = 1.5A (5A)
 Ch 1: INH_EN Ch 2: Vsb Ch 3: Vo CH 4: G_DCOK_C

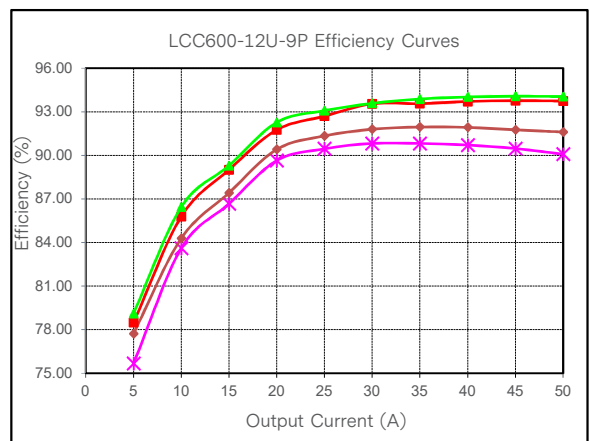

Figure 10: LCC600-12U-9P Efficiency Curve @ 25°C
 Loading: Io_main = 10%Io_max increment to 50A, Isb=1.5A

ELECTRICAL SPECIFICATIONS

LCC600-12H-9P Performance Curves

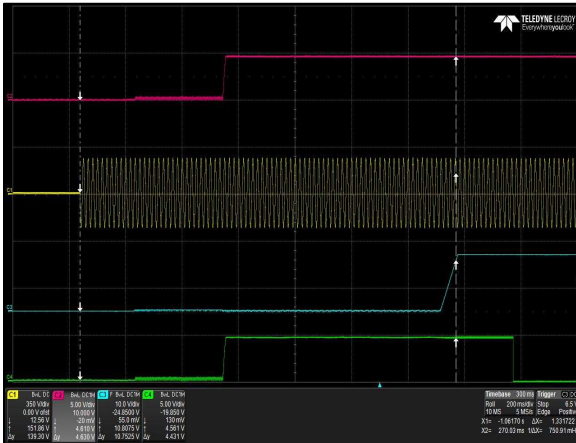

Figure 11: LCC600-12H-9P Turn-on delay via AC mains
 Vin = 180Vac Load: I_O = 50A (12V), I_{SB} = 1.5A (5V)
 Ch 1: AC Mains Ch 2: V_{SB} Ch 3: V_O CH 4: G_DCOK_C

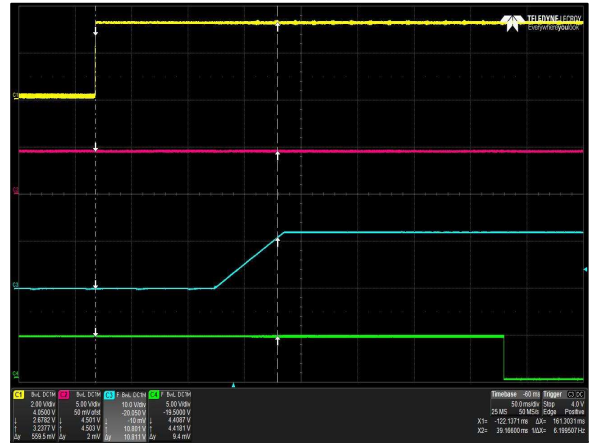

Figure 12: LCC600-12H-9P Turn-on delay via INH_EN
 Vin = 180Vac Load: I_O = 50A (12V), I_{SB} = 1.5A (5V)
 Ch 1: INH_EN Ch 2: V_{SB} Ch 3: V_O CH 4: G_DCOK_C

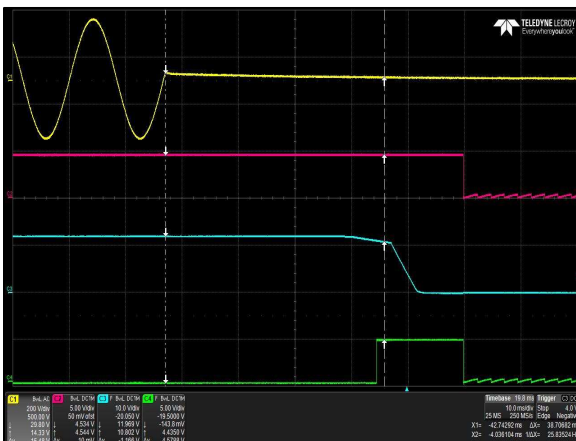

Figure 13: LCC600-12H-9P Hold-up Time
 Vin = 180Vac / 63Hz / 0° Load: I_O = 50A (12V), I_{SB} = 1.5A (5V)
 Ch 1: AC Mains Ch 2: V_{SB} Ch 3: V_O CH 4: G_DCOK_C

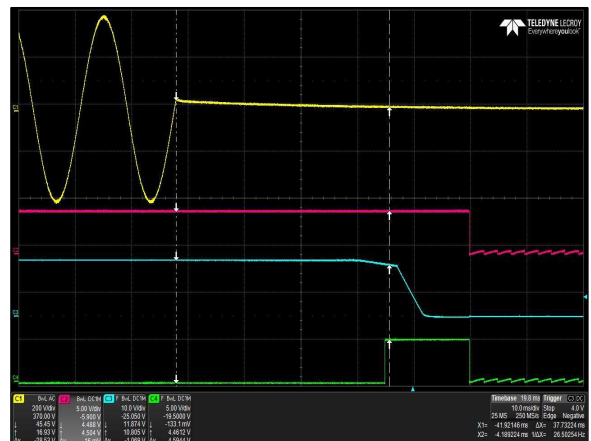

Figure 14: LCC600-12H-9P Hold-up Time
 Vin = 305Vac / 47Hz / 0° Load: I_O = 50A (12V), I_{SB} = 1.5A (5V)
 Ch 1: AC Mains Ch 2: V_{SB} Ch 3: V_O CH 4: G_DCOK_C

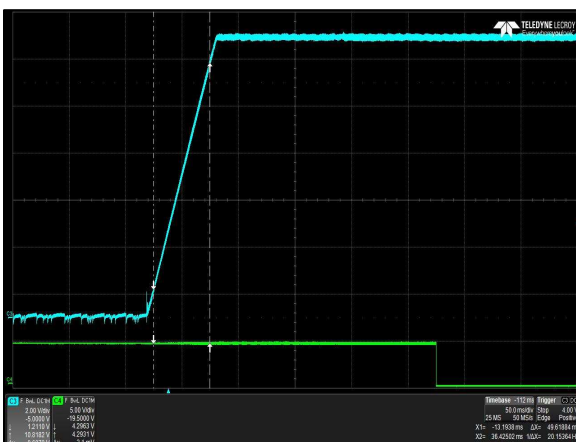

Figure 15: LCC600-12H-9P Output Startup Characteristic
 Vin = 180Vac Load: I_O = 50A (12V), I_{SB} = 1.5A (5V)
 Ch 1: V_O Ch 2: G_DCOK_C

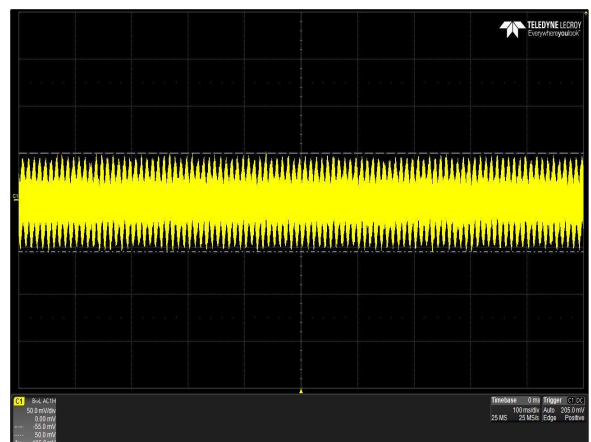

Figure 16: LCC600-12H-9P Ripple and Noise Measurement
 Vin = 180Vac Load: I_O = 50A (12V), I_{SB} = 1.5A (5V)
 Ch 1: V_O

ELECTRICAL SPECIFICATIONS

LCC600-12H-9P Performance Curves

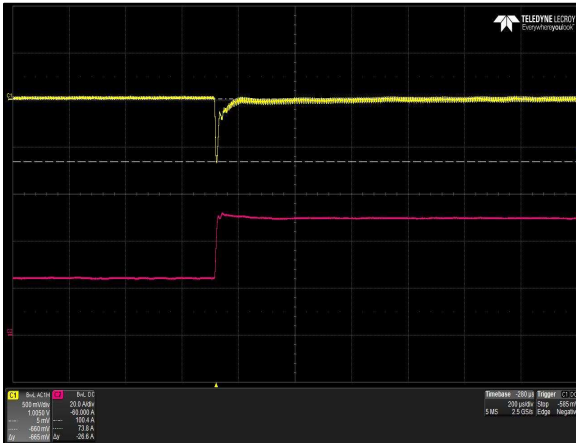

Figure 17: LCC600-12H-9P Transient Response - V_O Deviation
 50% to 100% load change 1A/uS slew rate $V_{in} = 277V_{ac}$
 Ch 1: V_O Ch 2: I_O

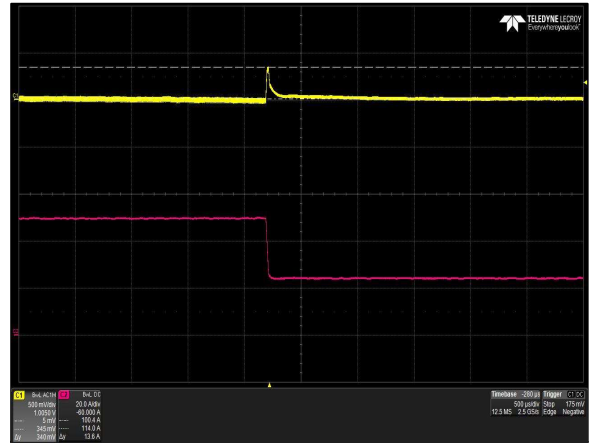

Figure 18: LCC600-12H-9P Transient Response - V_O Deviation
 100% to 50% load change 1A/uS slew rate $V_{in} = 277V_{ac}$
 Ch 1: V_O Ch 2: I_O

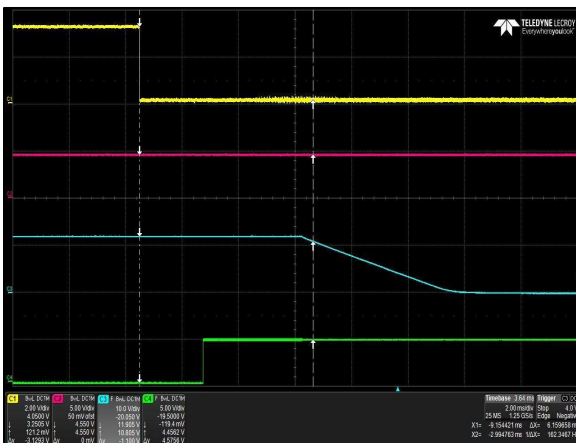

Figure 19: LCC600-12H-9P Turn Off Characteristic via INH_EN
 Load: $I_O = 50A$ (12V), $I_{SB} = 1.5A$ (5A)
 Ch 1: INH_EN Ch 2: V_{SB} Ch 3: V_O CH 4: G_DCOK_C

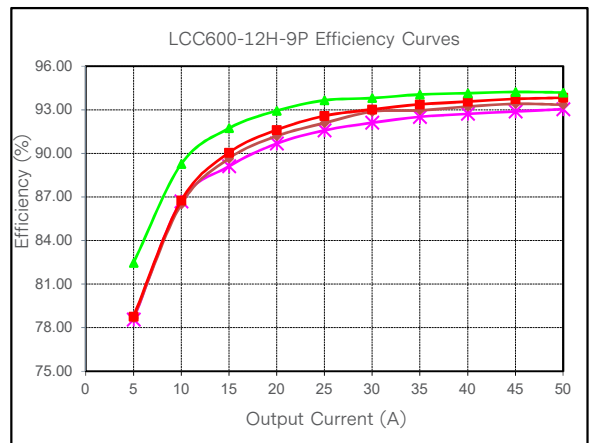

Figure 20: LCC600-12H-9P Efficiency Curve @ 25°C
 Loading: $I_{O_main} = 10\%I_{O_max}$ increment to 50A, $I_{SB}=1.5A$

ELECTRICAL SPECIFICATIONS

LCC600-28U-9P Performance Curves

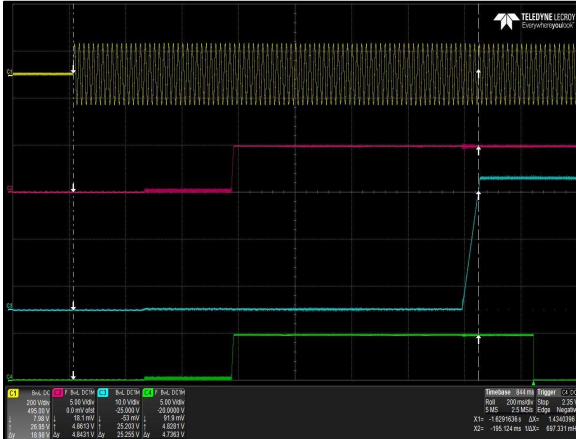

Figure 21: LCC600-28U-9P Turn-on delay via AC mains
 Vin = 90Vac Load: I_O = 21.5A (28V), I_{SB} = 1.5A (5V)
 Ch 1: AC Mains Ch 2: V_{SB} Ch 3: V_O CH 4: G_DCOK_C



Figure 22: LCC600-28U-9P Turn-on delay via INH_EN
 Vin = 90Vac Load: I_O = 21.5A (28V), I_{SB} = 1.5A (5V)
 Ch 1: INH_EN Ch 2: V_{SB} Ch 3: V_O CH 4: G_DCOK_C

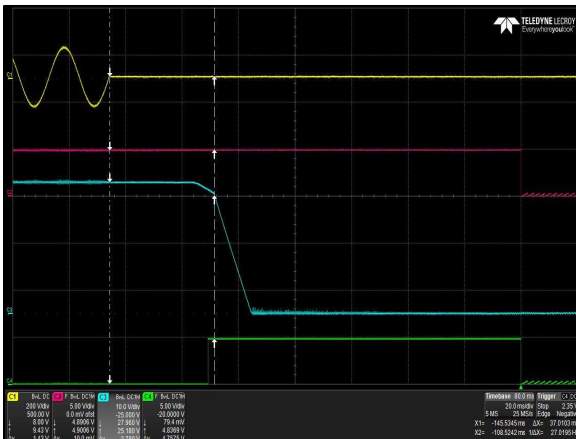

Figure 23: LCC600-28U-9P Hold-up Time
 Vin = 90Vac / 63Hz / 0° Load: I_O = 21.5A (28V), I_{SB} = 1.5A (5V)
 Ch 1: AC Mains Ch 2: V_{SB} Ch 3: V_O CH 4: G_DCOK_C

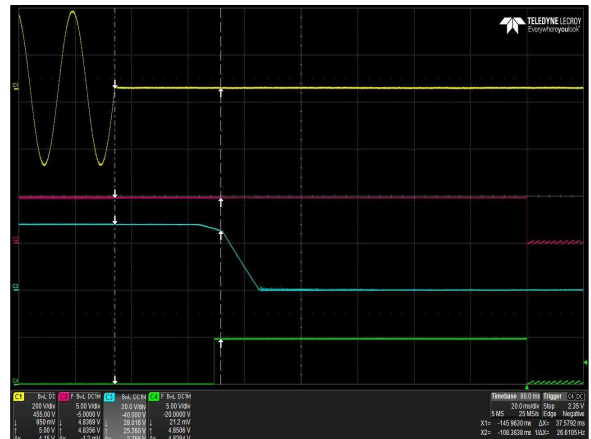

Figure 24: LCC600-28U-9P Hold-up Time
 Vin = 264Vac / 47Hz / 0° Load: I_O = 21.5A (28V), I_{SB} = 1.5A (5V)
 Ch 1: AC Mains Ch 2: V_{SB} Ch 3: V_O CH 4: G_DCOK_C

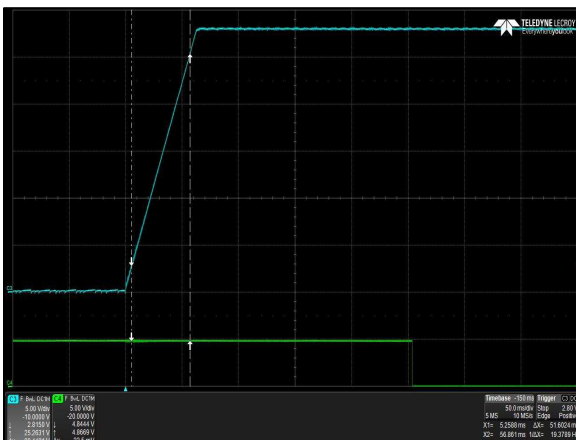

Figure 25: LCC600-28U-9P Output Startup Characteristic
 Vin = 90Vac Load: I_O = 21.5A (28V), I_{SB} = 1.5A (5V)
 Ch 1: V_O Ch 2: G_DCOK_C

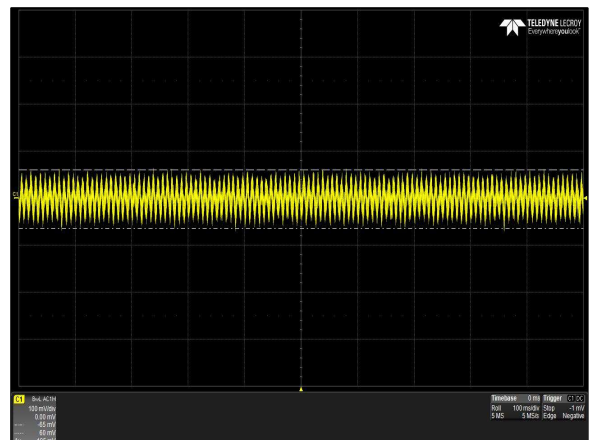
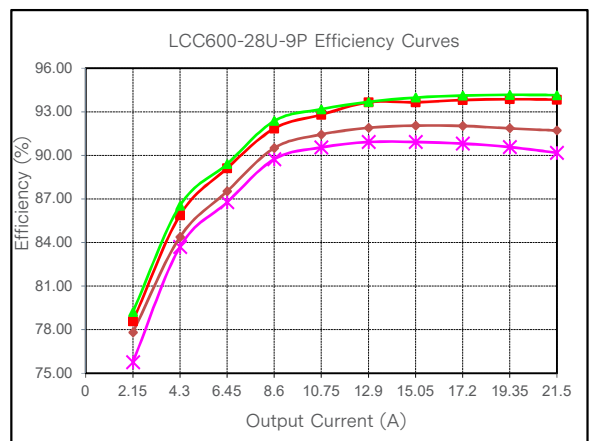
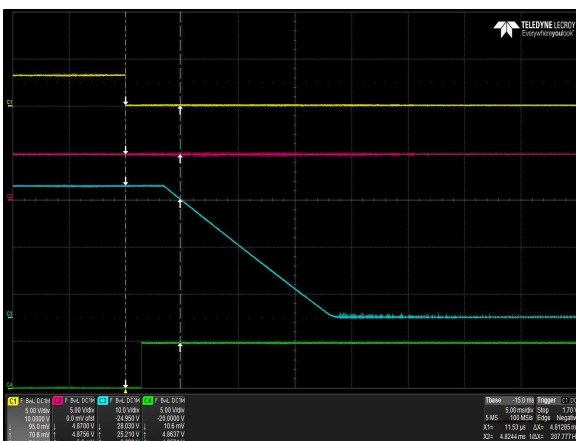
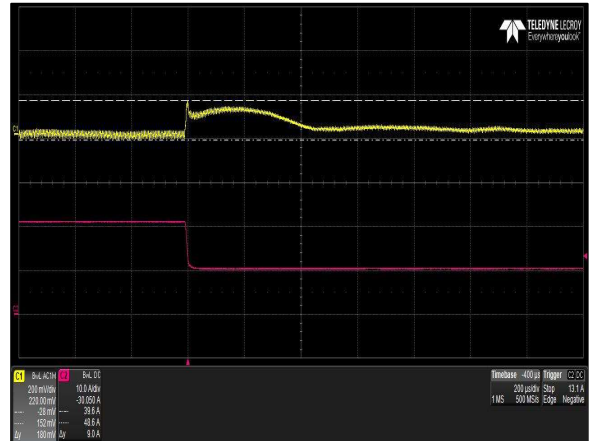
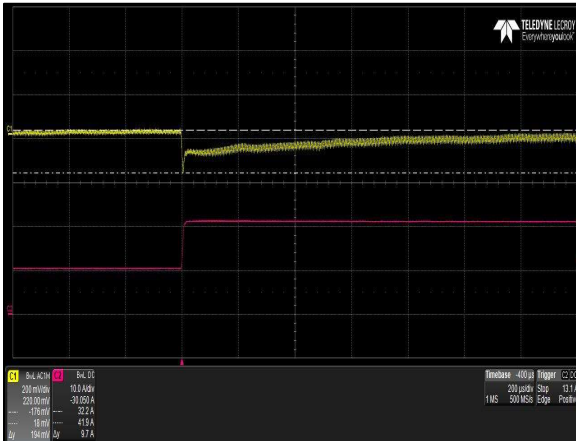

Figure 26: LCC600-28U-9P Ripple and Noise Measurement
 Vin = 90Vac Load: I_O = 21.5A (28V), I_{SB} = 1.5A (5V)
 Ch 1: V_O

ELECTRICAL SPECIFICATIONS

LCC600-28U-9P Performance Curves



ELECTRICAL SPECIFICATIONS

LCC600-28H-9P Performance Curves

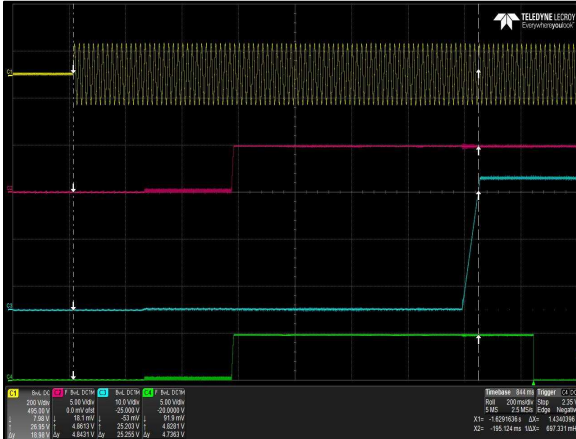

Figure 31: LCC600-28H-9P Turn-on delay via AC mains
 Vin = 180Vac Load: I_O = 21.5A (28V), I_{SB} = 1.5A (5V)
 Ch 1: AC Mains Ch 2: V_{SB} Ch 3: V_O CH 4: G_DCOK_C



Figure 32: LCC600-28H-9P Turn-on delay via INH_EN
 Vin = 180Vac Load: I_O = 21.5A (28V), I_{SB} = 1.5A (5V)
 Ch 1: INH_EN Ch 2: V_{SB} Ch 3: V_O CH 4: G_DCOK_C

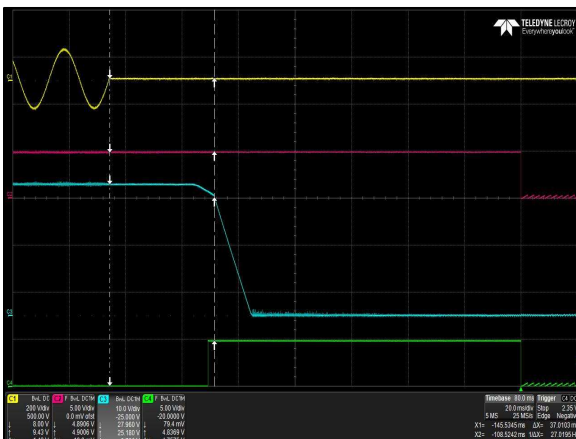

Figure 33: LCC600-28H-9P Hold-up Time
 Vin = 180Vac / 63Hz / 0° Load: I_O = 21.5A (28V), I_{SB} = 1.5A (5V)
 Ch 1: AC Mains Ch 2: V_{SB} Ch 3: V_O CH 4: G_DCOK_C

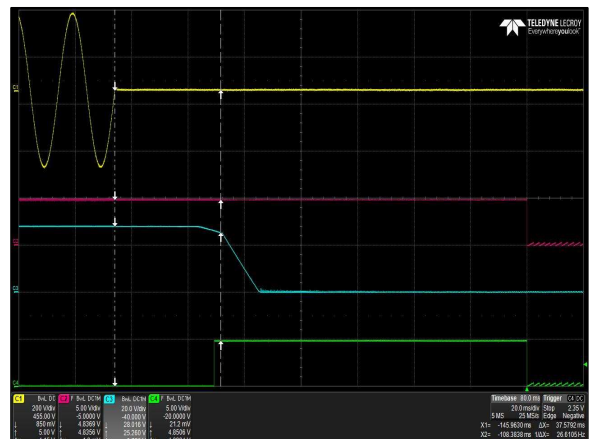

Figure 34: LCC600-28H-9P Hold-up Time
 Vin = 305Vac / 47Hz / 0° Load: I_O = 21.5A (28V), I_{SB} = 1.5A (5V)
 Ch 1: AC Mains Ch 2: V_{SB} Ch 3: V_O CH 4: G_DCOK_C

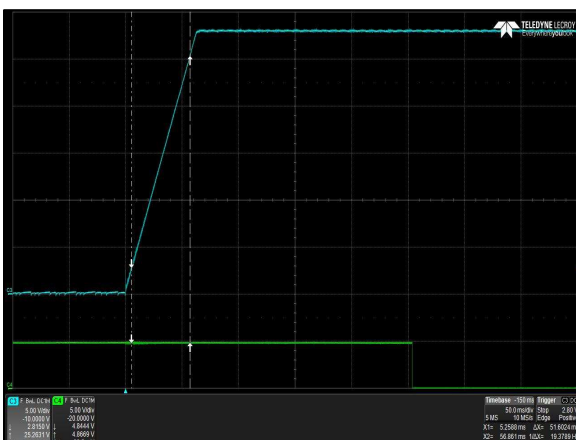

Figure 35: LCC600-28H-9P Output Startup Characteristic
 Vin = 180Vac Load: I_O = 21.5A (28V), I_{SB} = 1.5A (5V)
 Ch 1: V_O Ch 2: G_DCOK_C

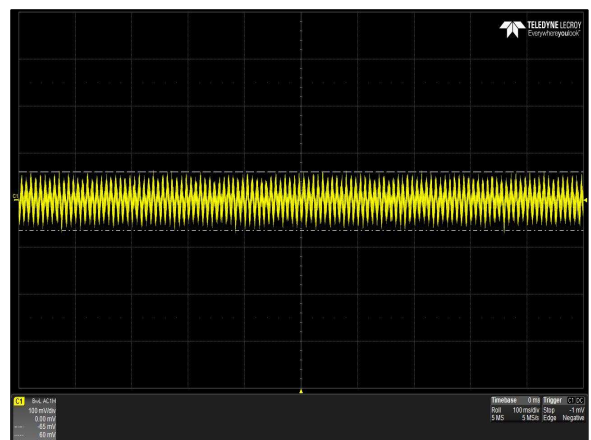
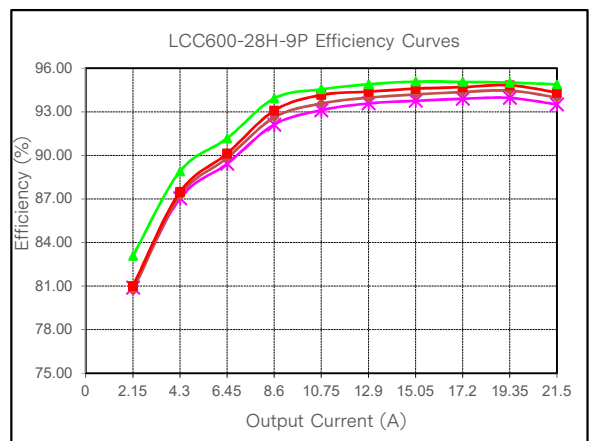
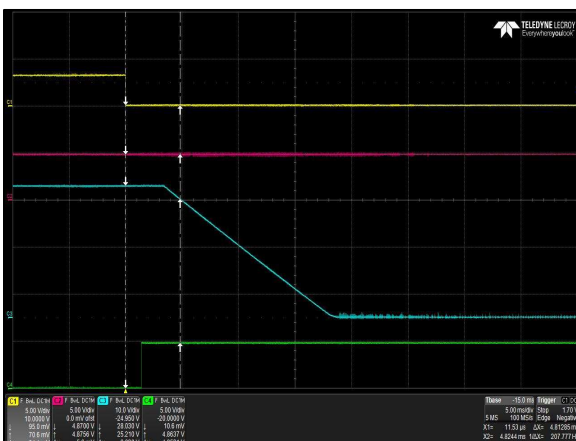
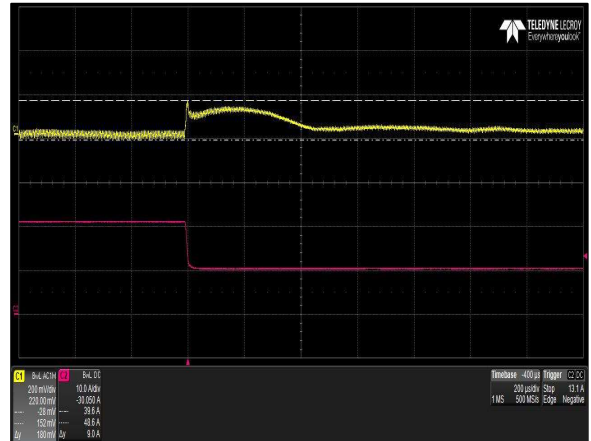
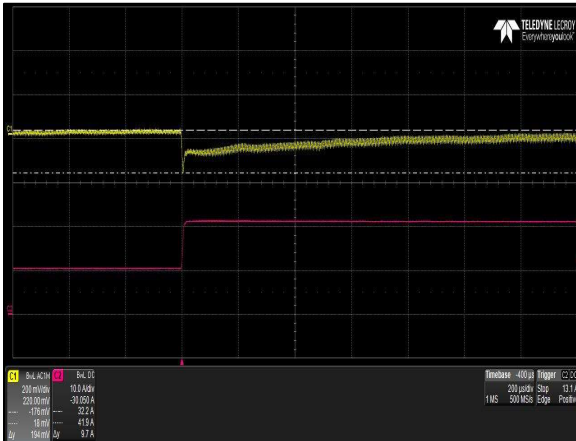

Figure 36: LCC600-28H-9P Ripple and Noise Measurement
 Vin = 180Vac Load: I_O = 21.5A (28V), I_{SB} = 1.5A (5V)
 Ch 1: V_O

ELECTRICAL SPECIFICATIONS

LCC600-28H-9P Performance Curves



ELECTRICAL SPECIFICATIONS

LCC600-36U-9P Performance Curves

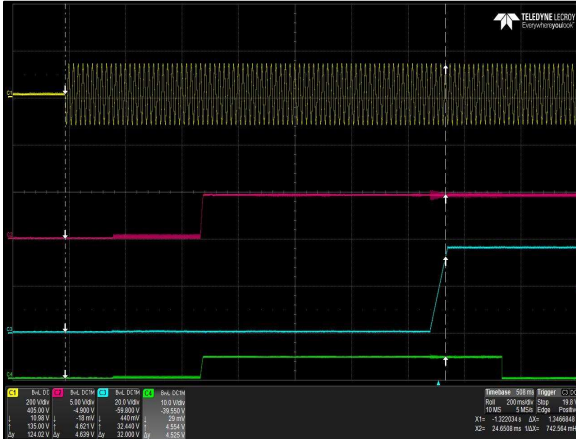

Figure 41: LCC600-36U-9P Turn-on delay via AC mains
 Vin = 90Vac Load: I_O = 16.7A (36V), I_{SB} = 1.5A (5V)
 Ch 1: AC Mains Ch 2: V_{SB} Ch 3: V_O CH 4: G_DCOK_C



Figure 42: LCC600-36U-9P Turn-on delay via INH_EN
 Vin = 90Vac Load: I_O = 16.7A (36V), I_{SB} = 1.5A (5V)
 Ch 1: INH_EN Ch 2: V_{SB} Ch 3: V_O CH 4: G_DCOK_C

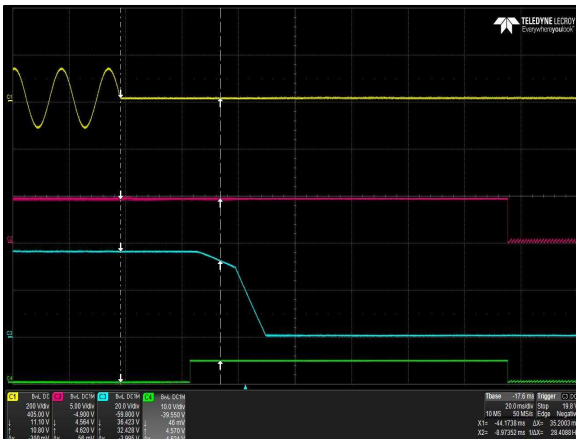

Figure 43: LCC600-36U-9P Hold-up Time
 Vin = 90Vac / 63Hz / 0° Load: I_O = 16.7A (36V), I_{SB} = 1.5A(5V)
 Ch 1: AC Mains Ch 2: V_{SB} Ch 3: V_O CH 4: G_DCOK_C

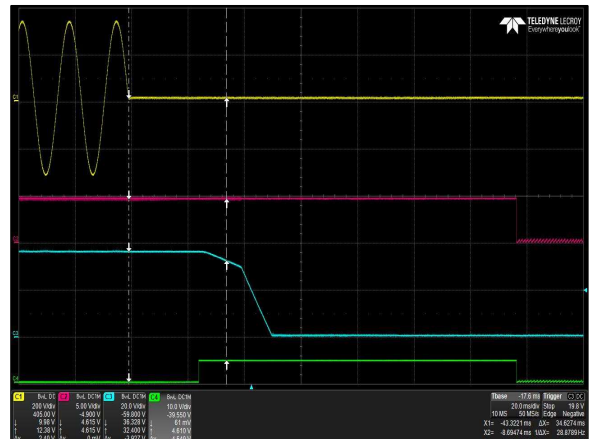

Figure 44: LCC600-36U-9P Hold-up Time
 Vin = 264Vac / 47Hz / 0° Load: I_O = 16.7A (36V), I_{SB} = 1.5A (5V)
 Ch 1: AC Mains Ch 2: V_{SB} Ch 3: V_O CH 4: G_DCOK_C

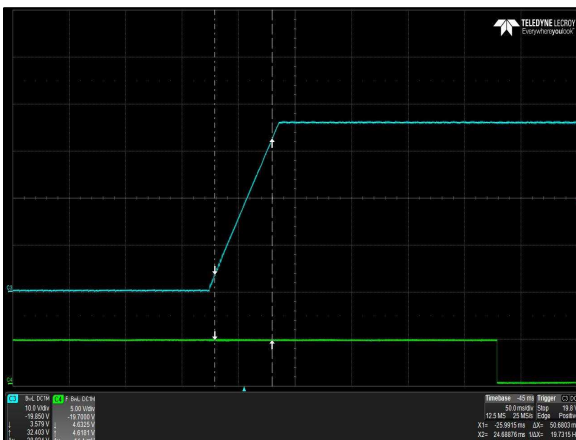

Figure 45: LCC600-36U-9P Output Startup Characteristic
 Vin = 90Vac Load: I_O = 16.7A (36V), I_{SB} = 1.5A (5V)
 Ch 1: V_O Ch 2: G_DCOK_C

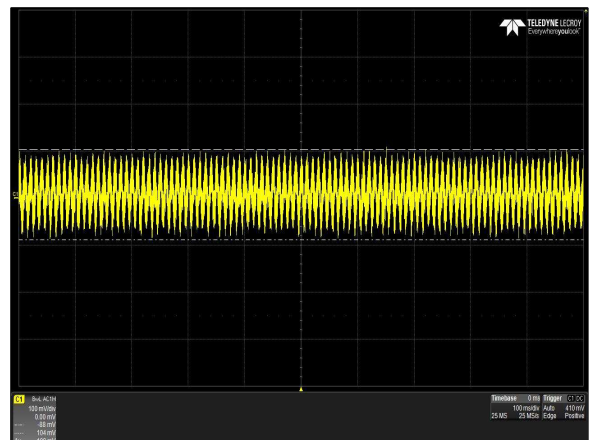

Figure 46: LCC600-36U-9P Ripple and Noise Measurement
 Vin = 90Vac Load: I_O = 16.7A (36V), I_{SB} = 1.5A (5V)
 Ch 1: V_O

ELECTRICAL SPECIFICATIONS

LCC600-36U-9P Performance Curves

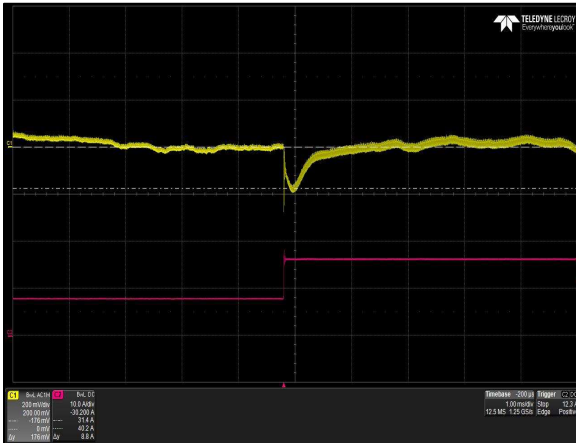

Figure 47: LCC600-36U-9P Transient Response - V_O Deviation
 50% to 100% load change 1A/uS slew rate $V_{in} = 230V_{ac}$
 Ch 1: V_O Ch 2: I_O

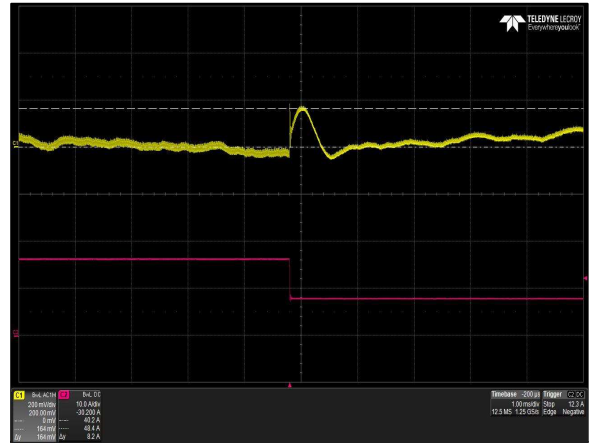

Figure 48: LCC600-36U-9P Transient Response - V_O Deviation
 100% to 50% load change 1A/uS slew rate $V_{in} = 230V_{ac}$
 Ch 1: V_O Ch 2: I_O

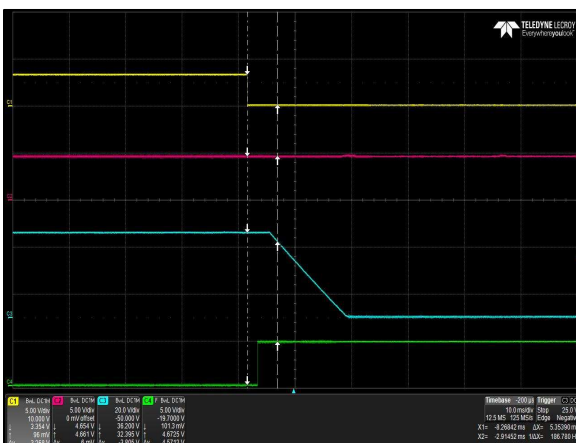

Figure 49: LCC600-36U-9P Turn Off Characteristic via INH_EN
 Load: $I_O = 16.7A$ (36V), $I_{SB} = 1.5A$ (5A)
 Ch 1: INH_EN Ch 2: V_{SB} Ch 3: V_O CH 4: G_DCOK_C

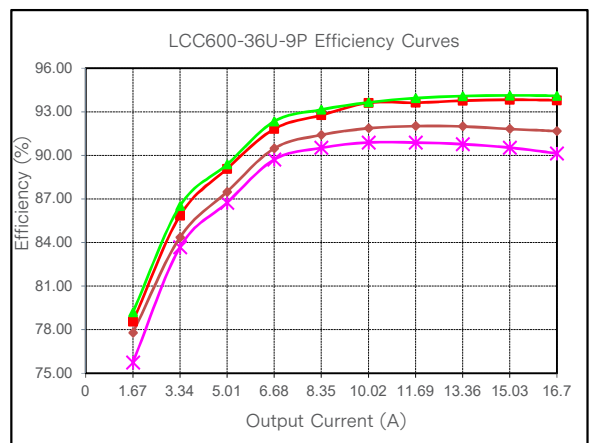

Figure 50: LCC600-36U-9P Efficiency Curve @ 25°C
 Loading: $I_{O_main} = 10\%I_{O_max}$ increment to 16.7A, $I_{SB}=1.5A$

ELECTRICAL SPECIFICATIONS

LCC600-36H-9P Performance Curves

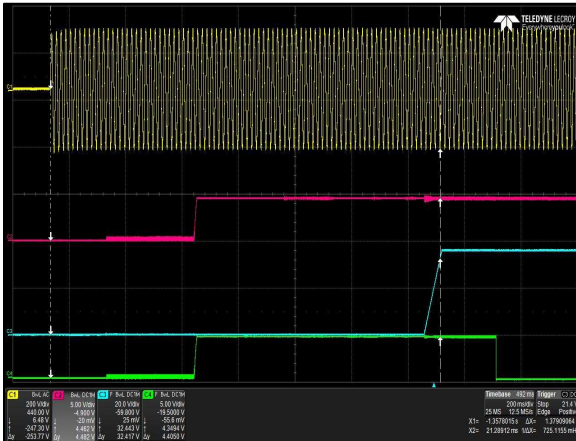

Figure 51: LCC600-36H-9P Turn-on delay via AC mains
 Vin = 180Vac Load: I_O = 16.7A (36V), I_{SB} = 1.5A (5V)
 Ch 1: AC Mains Ch 2: V_{SB} Ch 3: V_O CH 4: G_DCOK_C

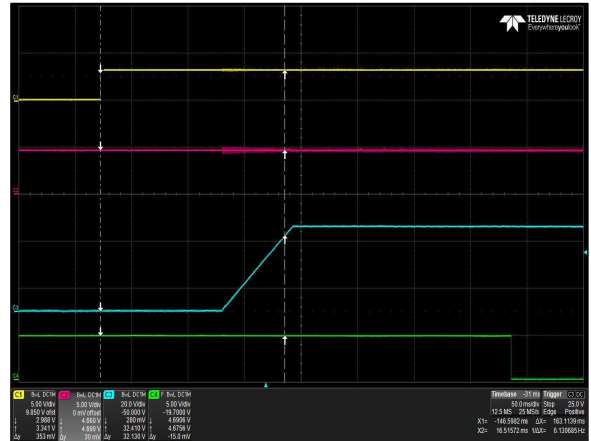

Figure 52: LCC600-36H-9P Turn-on delay via INH_EN
 Vin = 180Vac Load: I_O = 16.7A (36V), I_{SB} = 1.5A (5V)
 Ch 1: INH_EN Ch 2: V_{SB} Ch 3: V_O CH 4: G_DCOK_C

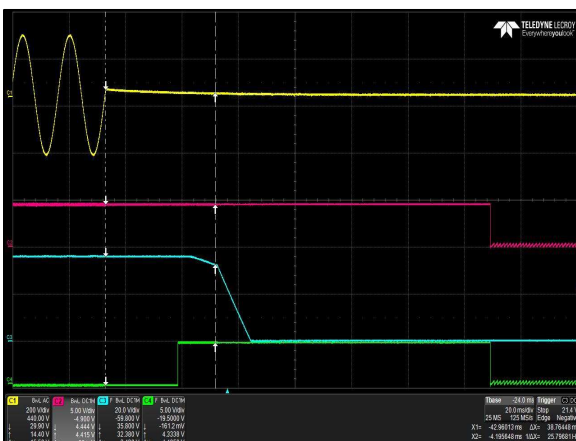

Figure 53: LCC600-36H-9P Hold-up Time
 Vin = 180Vac / 63Hz / 0° Load: I_O = 16.7A (36V), I_{SB} = 1.5A (5V)
 Ch 1: AC Mains Ch 2: V_{SB} Ch 3: V_O CH 4: G_DCOK_C

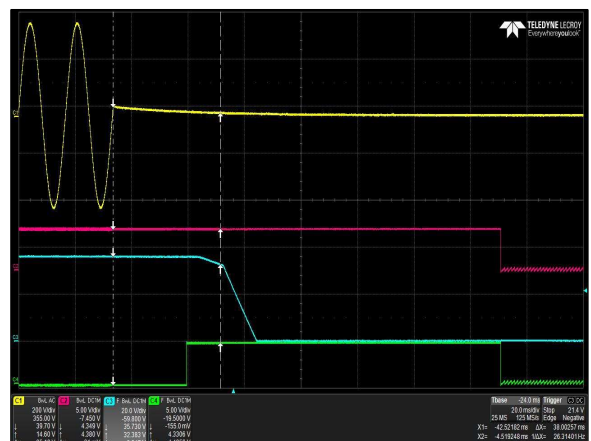

Figure 54: LCC600-36H-9P Hold-up Time
 Vin = 305Vac / 47Hz / 0° Load: I_O = 16.7A (36V), I_{SB} = 1.5A (5V)
 Ch 1: AC Mains Ch 2: V_{SB} Ch 3: V_O CH 4: G_DCOK_C

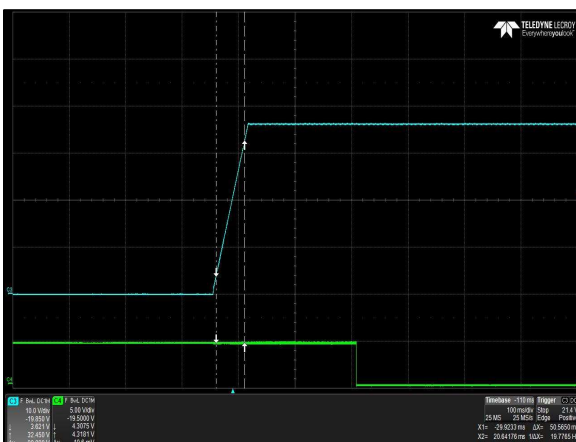

Figure 55: LCC600-36H-9P Output Startup Characteristic
 Vin = 180Vac Load: I_O = 16.7A (36V), I_{SB} = 1.5A (5V)
 Ch 1: V_O Ch 2: G_DCOK_C

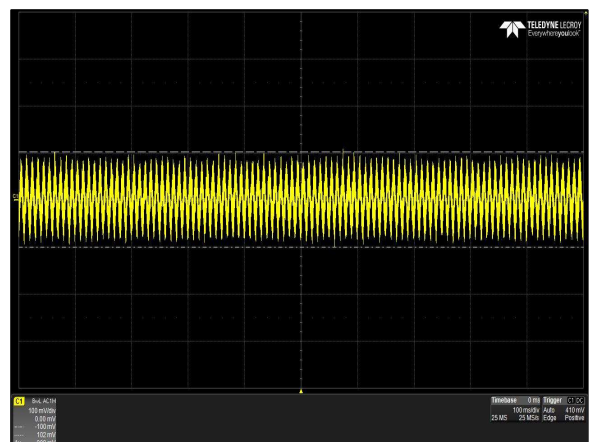

Figure 56: LCC600-36H-9P Ripple and Noise Measurement
 Vin = 180Vac Load: I_O = 16.7A (36V), I_{SB} = 1.5A (5V)
 Ch 1: V_O

ELECTRICAL SPECIFICATIONS

LCC600-36H-9P Performance Curves

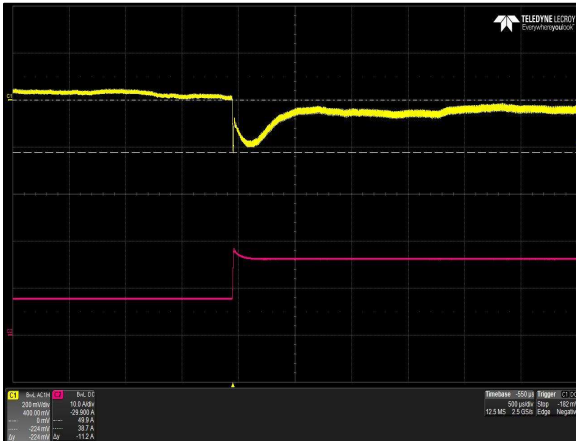

Figure 57: LCC600-36H-9P Transient Response - V_O Deviation
 50% to 100% load change 1A/uS slew rate $V_{in} = 277V_{ac}$
 Ch 1: V_O Ch 2: I_O

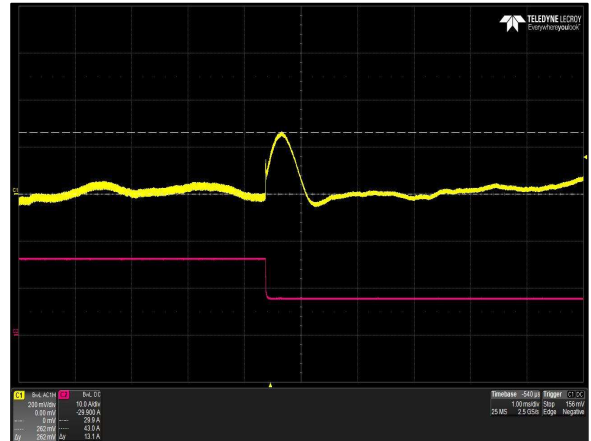

Figure 58: LCC600-36H-9P Transient Response - V_O Deviation
 100% to 50% load change 1A/uS slew rate $V_{in} = 277V_{ac}$
 Ch 1: V_O Ch 2: I_O

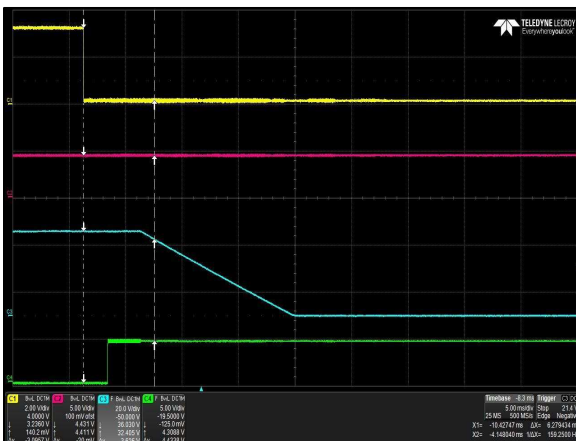

Figure 59: LCC600-36H-9P Turn Off Characteristic via INH_EN
 Load: $I_O = 16.7A$ (36V), $I_{SB} = 1.5A$ (5A)
 Ch 1: INH_EN Ch 2: V_{SB} Ch 3: V_O CH 4: G_DCOK_C

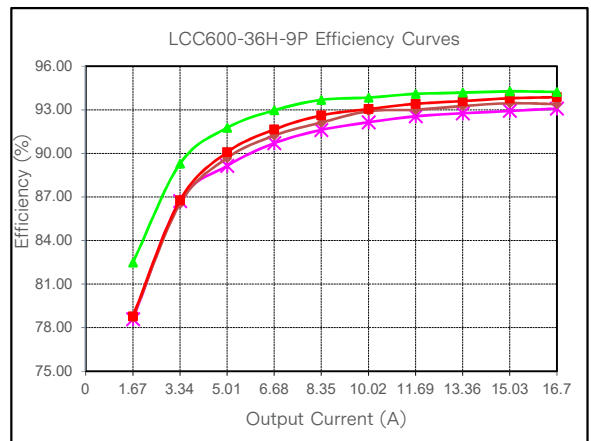

Figure 60: LCC600-36H-9P Efficiency Curve @ 25°C
 Loading: $I_{O_main} = 10\%I_{O_max}$ increment to 16.7A, $I_{SB}=1.5A$

ELECTRICAL SPECIFICATIONS

LCC600-48H-9P Performance Curves

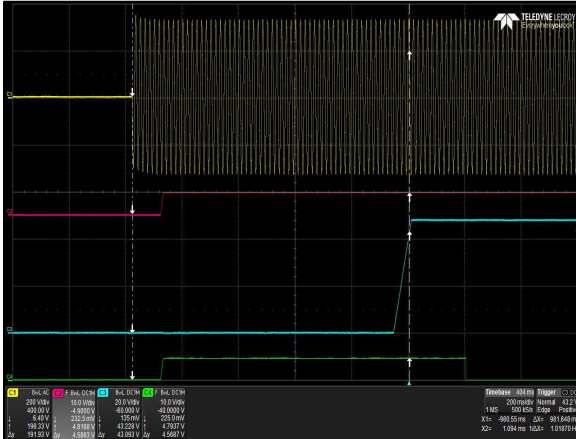

Figure 71: LCC600-48H-9P Turn-on delay via AC mains
 Vin = 180Vac Load: I_O = 12.5A (48V), I_{SB} = 1.5A (5V)
 Ch 1: AC Mains Ch 2: V_{SB} Ch 3: V_O CH 4: G_DCOK_C

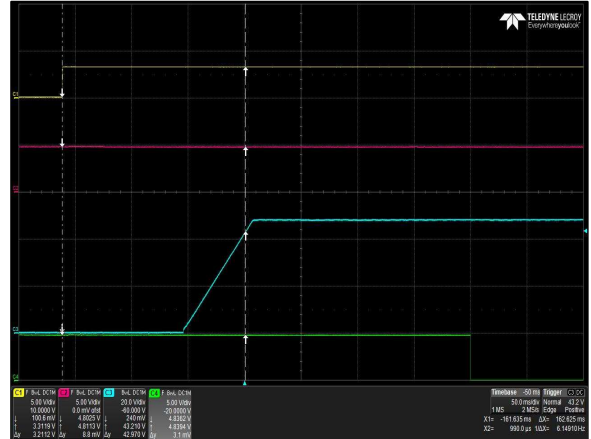

Figure 72: LCC600-48H-9P Turn-on delay via INH_EN
 Vin = 180Vac Load: I_O = 12.5A (48V), I_{SB} = 1.5A (5V)
 Ch 1: INH_EN Ch 2: V_{SB} Ch 3: V_O CH 4: G_DCOK_C

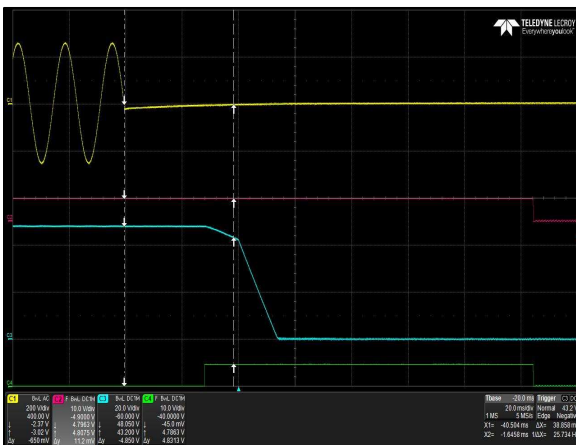

Figure 73: LCC600-48H-9P Hold-up Time
 Vin = 180Vac / 63Hz / 0° Load: I_O = 12.5A (48V), I_{SB} = 1.5A (5V)
 Ch 1: AC Mains Ch 2: V_{SB} Ch 3: V_O CH 4: G_DCOK_C

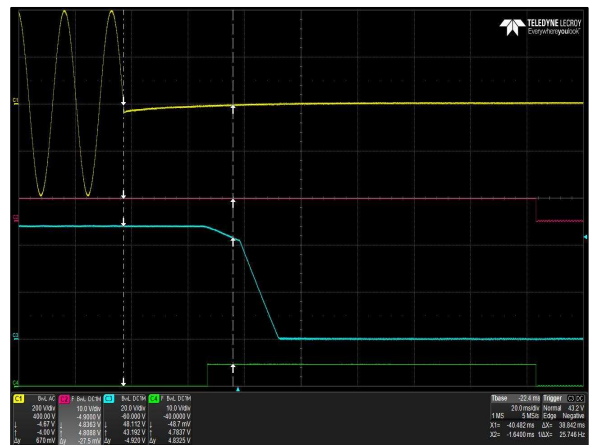

Figure 74: LCC600-48H-9P Hold-up Time
 Vin = 305Vac / 47Hz / 0° Load: I_O = 12.5A (48V), I_{SB} = 1.5A (5V)
 Ch 1: AC Mains Ch 2: V_{SB} Ch 3: V_O CH 4: G_DCOK_C

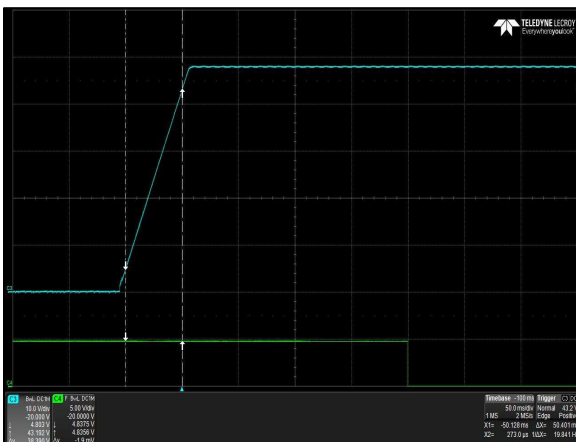

Figure 75: LCC600-48H-9P Output Startup Characteristic
 Vin = 180Vac Load: I_O = 12.5A (48V), I_{SB} = 1.5A (5V)
 Ch 1: V_O Ch 2: G_DCOK_C

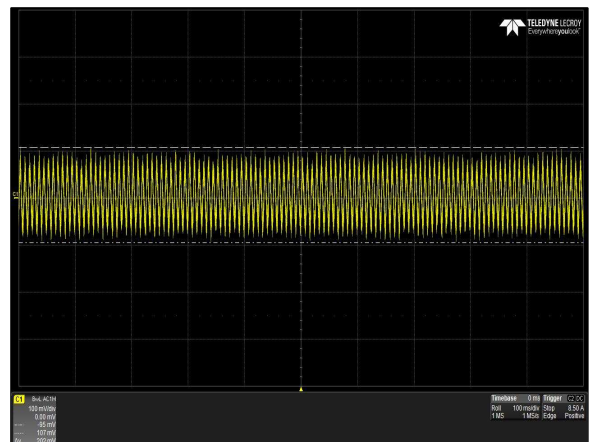

Figure 76: LCC600-48H-9P Ripple and Noise Measurement
 Vin = 180Vac Load: I_O = 12.5A (48V), I_{SB} = 1.5A (5V)
 Ch 1: V_O

ELECTRICAL SPECIFICATIONS

LCC600-48H-9P Performance Curves

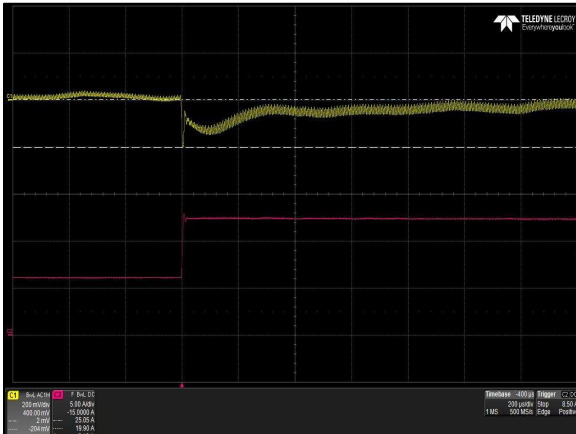

Figure 77: LCC600-48H-9P Transient Response - V_O Deviation
 50% to 100% load change 1A/uS slew rate $V_{in} = 277V_{ac}$
 Ch 1: V_O Ch 2: I_O

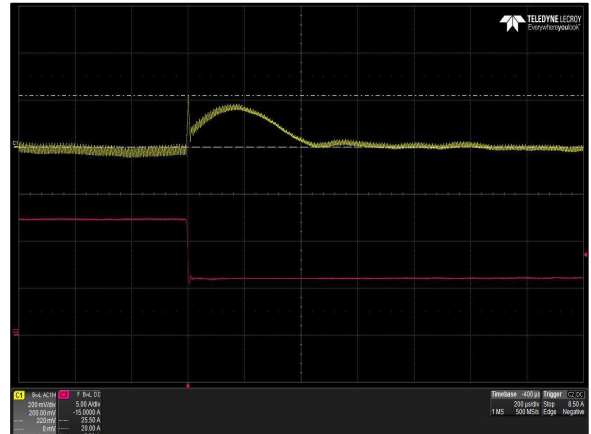

Figure 78: LCC600-48H-9P Transient Response - V_O Deviation
 100% to 50% load change 1A/uS slew rate $V_{in} = 277V_{ac}$
 Ch 1: V_O Ch 2: I_O



Figure 79: LCC600-48H-9P Turn Off Characteristic via INH_EN
 Load: $I_O = 12.5A$ (48V), $I_{SB} = 1.5A$ (5A)
 Ch 1: INH_EN Ch 2: V_{SB} Ch 3: V_O Ch 4: G_DCOK_C

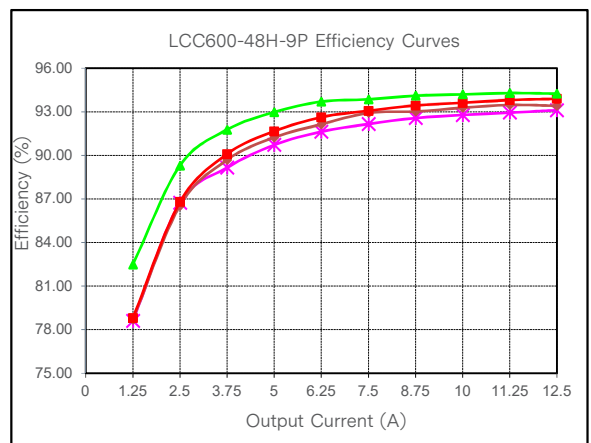

Figure 80: LCC600-48H-9P Efficiency Curve @ 25°C
 Loading: $I_{O_main} = 10\%I_{O_max}$ increment to 12.5A, $I_{SB}=1.5A$

ELECTRICAL SPECIFICATIONS

LCC600-48U-9P Performance Curves

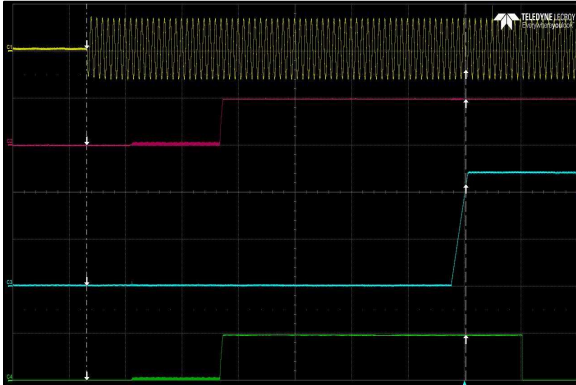

Figure 61: LCC600-48U-9P Turn-on delay via AC mains
 Vin = 90Vac Load: I_O = 12.5A (48V), I_{SB} = 1.5A (5V)
 Ch 1: AC Mains Ch 2: V_{SB} Ch 3: V_O CH 4: G_DCOK_C

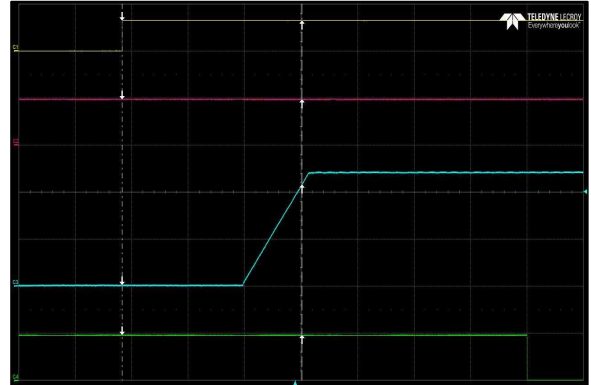

Figure 62: LCC600-48U-9P Turn-on delay via INH_EN
 Vin = 90Vac Load: I_O = 12.5A (48V), I_{SB} = 1.5A (5V)
 Ch 1: INH_EN Ch 2: V_{SB} Ch 3: V_O CH 4: G_DCOK_C



Figure 63: LCC600-48U-9P Hold-up Time
 Vin = 90Vac / 63Hz / 0° Load: I_O = 12.5A (48V), I_{SB} = 1.5A (5V)
 Ch 1: AC Mains Ch 2: V_{SB} Ch 3: V_O CH 4: G_DCOK_C

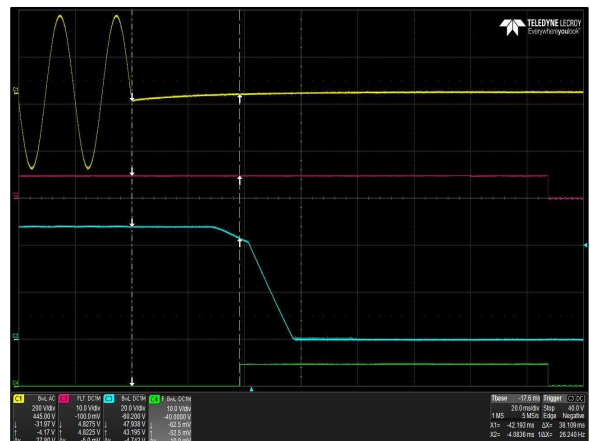

Figure 64: LCC600-48U-9P Hold-up Time
 Vin = 264Vac / 47Hz / 0° Load: I_O = 12.5A (48V), I_{SB} = 1.5A (5V)
 Ch 1: AC Mains Ch 2: V_{SB} Ch 3: V_O CH 4: G_DCOK_C

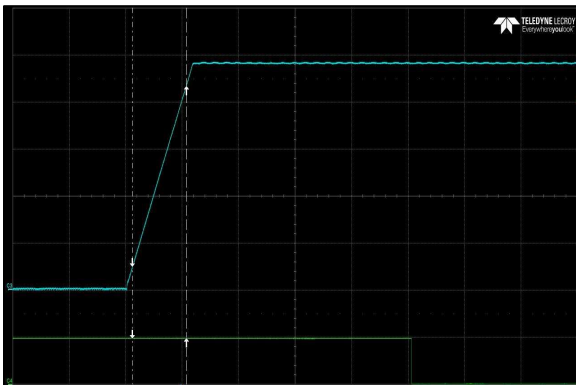

Figure 65: LCC600-48U-9P Output Startup Characteristic
 Vin = 90Vac Load: I_O = 12.5A (48V), I_{SB} = 1.5A (5V)
 Ch 1: V_O Ch 2: G_DCOK_C

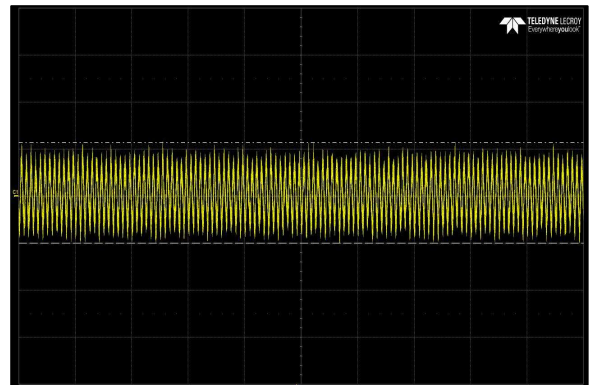

Figure 66: LCC600-48U-9P Ripple and Noise Measurement
 Vin = 90Vac Load: I_O = 12.5A (48V), I_{SB} = 1.5A (5V)
 Ch 1: V_O

ELECTRICAL SPECIFICATIONS

LCC600-48U-9P Performance Curves

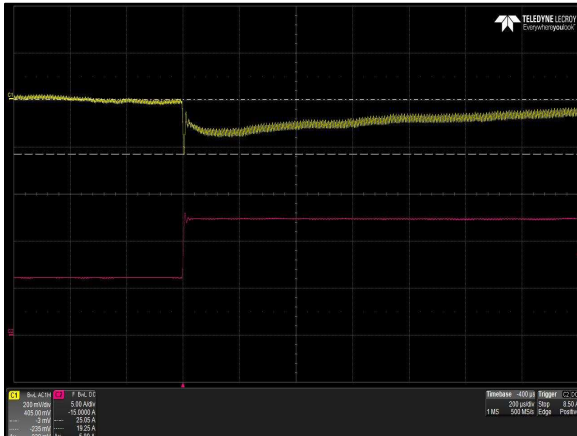

Figure 67: LCC600-48U-9P Transient Response - V_O Deviation
 50% to 100% load change 1A/uS slew rate $V_{in} = 230V_{ac}$
 Ch 1: V_O Ch 2: I_O

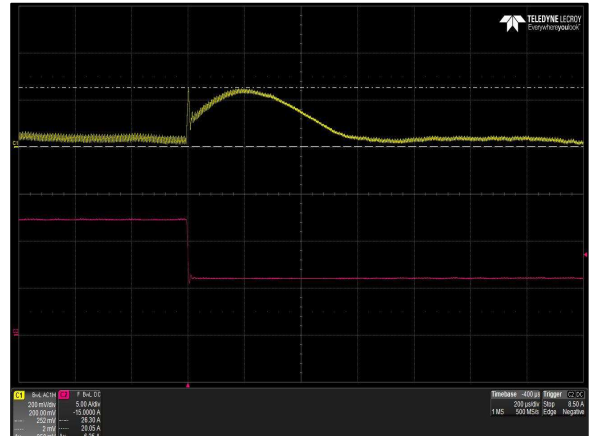

Figure 68: LCC600-48U-9P Transient Response - V_O Deviation
 100% to 50% load change 1A/uS slew rate $V_{in} = 230V_{ac}$
 Ch 1: V_O Ch 2: I_O



Figure 69: LCC600-48U-9P Turn Off Characteristic via INH_EN
 Load: $I_O = 12.5A$ (48V), $I_{SB} = 1.5A$ (5A)
 Ch 1: INH_EN Ch 2: V_{SB} Ch 3: V_O Ch 4: G_DCOK_C

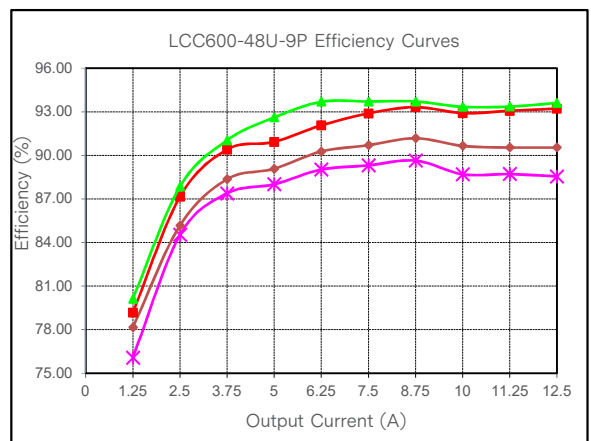

Figure 70: LCC600-48U-9P Efficiency Curve @ 25°C
 Loading: $I_{O_main} = 10\%I_{O_max}$ increment to 12.5A, $I_{SB}=1.5A$

ELECTRICAL SPECIFICATIONS

Protection Function Specifications

Input Fuse

LCC600 -U suffix module is equipped with an internal non user serviceable 12.5A high rupturing capacity (HRC) 250 Vac fuse for fault protection in both the Live and Neutral lines input.

LCC600 -H suffix module is equipped with an internal non user serviceable 7A high rupturing capacity (HRC) 350 Vac fuse for fault protection in both the Live and Neutral lines input.

Over Voltage Protection (OVP)

The power supply latches off during output overvoltage with the AC line recycled to reset the latch.

Parameter	Min	Typ	Max	Unit
V _O Output Overvoltage	125	/	145	% V _O
Standby Voltage Overvoltage	125	/	155	% V _O

Over Current Protection (OCP)

LCC600 series includes internal current limit circuitry to prevent damage in the event of overload or short circuit. Recovery is automatic when the overload is removed. No damage will result to the supply as the result of either short term or long term overloads of the output. To be measured under all line and load conditions. In case of continued overload, main output will retry after 20sec. Optional constant current using hardware modification or digital methods is required as part of the design. CC mode supported up to the lowest output trim range.

Main Output Response: Output will shutdown and auto recover within a period 20sec. If overload still present after the 20sec time frame, main output will latch and needs AC recycle or inhibit toggling or thru PMbus command to turn unit back on.

5V Standby Response: Output will shutdown and auto recover within a period 20sec. If overload still present after the 20sec time frame, 5Vstandby and main output will latch needs AC recycle.

Parameter	Min	Typ	Max	Unit
V _O Output Overcurrent	105	/	130	% I _{O,max}
Standby Voltage Overcurrent	105	/	140	% I _{O,max}

Short Circuit Protection (SCP)

The LCC600 series will protect itself when any output is shorted to ground or to any other output. The power supply will withstand a continuous short circuit with no permanent damage, applied to its main output during start-up or while running.

Over Temperature Protection (OTP)

The power supply is internally protected against over temperature conditions. The OTP is auto recovery mode.

ELECTRICAL SPECIFICATIONS

Mechanical Outlines (unit: mm)

“-9P” Suffix

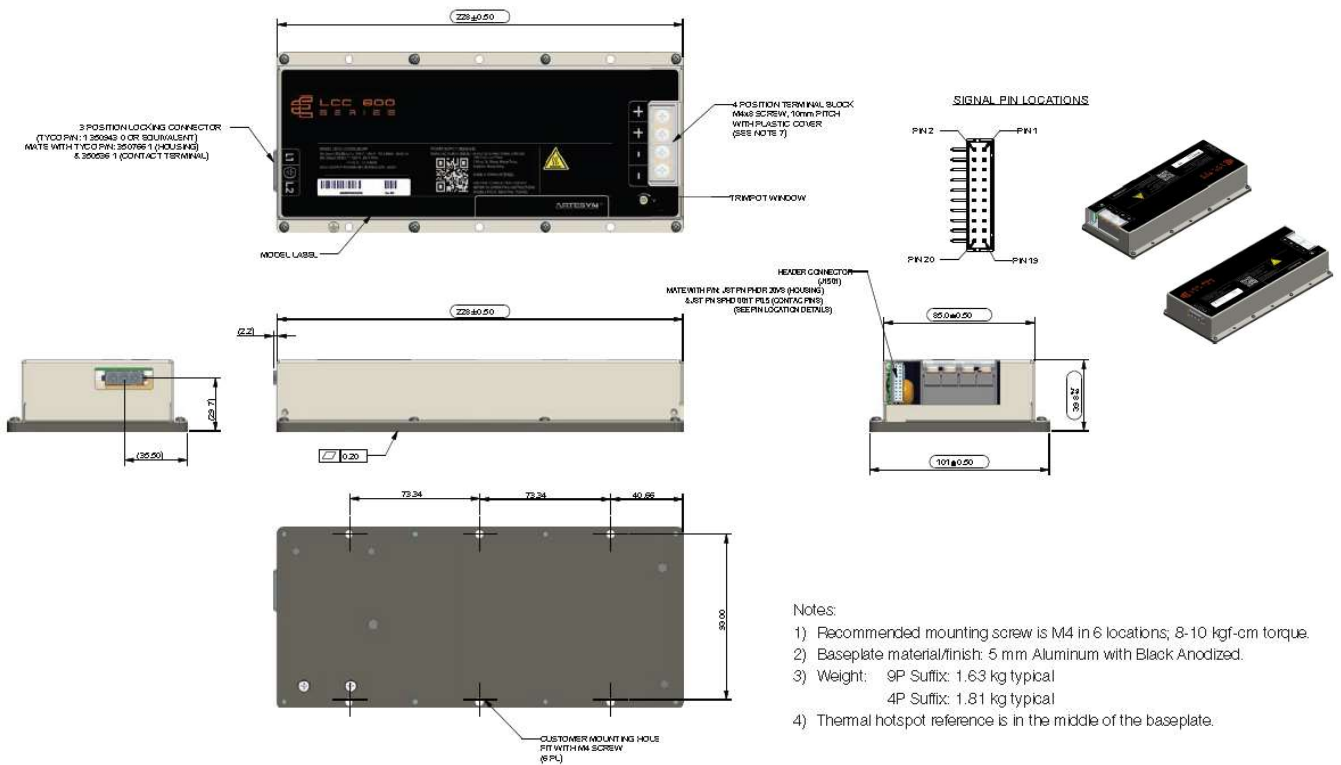

- Notes:
- 1) Recommended mounting screw is M4 in 6 locations; 8-10 kgf-cm torque.
 - 2) Baseplate material/finish: 5 mm Aluminum with Black Anodized.
 - 3) Weight: 9P Suffix: 1.63 kg typical
4P Suffix: 1.81 kg typical
 - 4) Thermal hotspot reference is in the middle of the baseplate.

ELECTRICAL SPECIFICATIONS

Mechanical Outlines (unit: mm)

“-4P” Suffix (12 Vdc)

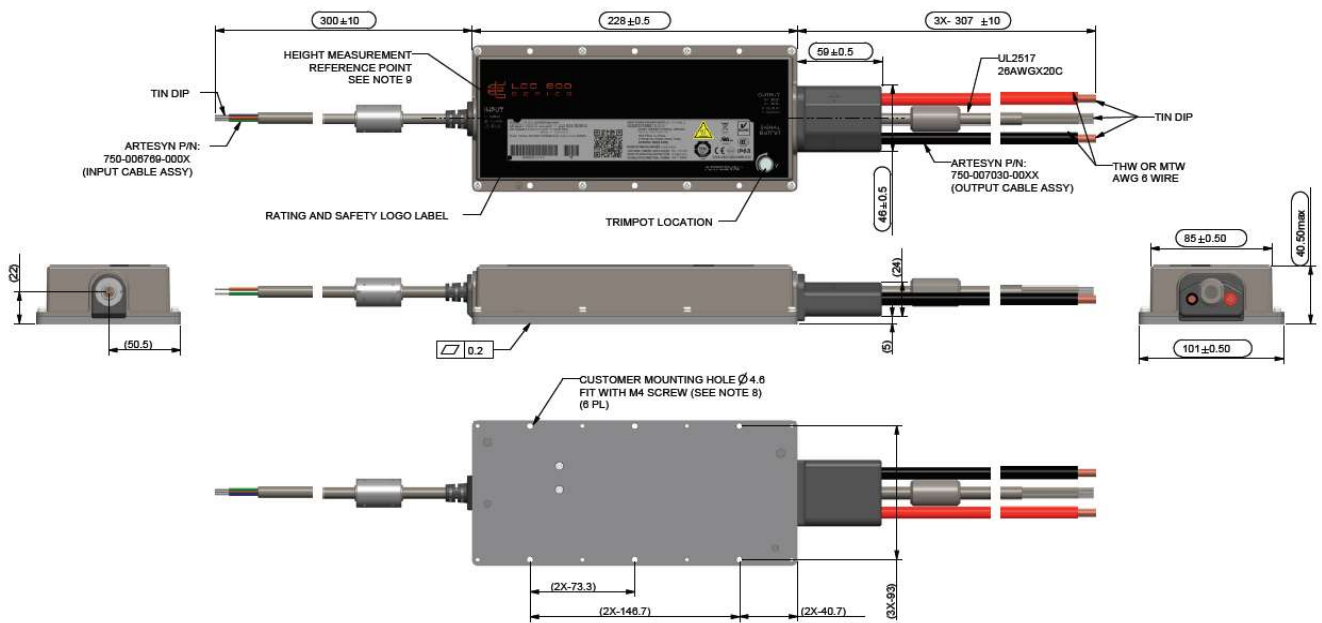

ELECTRICAL SPECIFICATIONS

Mechanical Outlines (unit: mm)

“-4P” Suffix (28, 36, 48 Vdc)

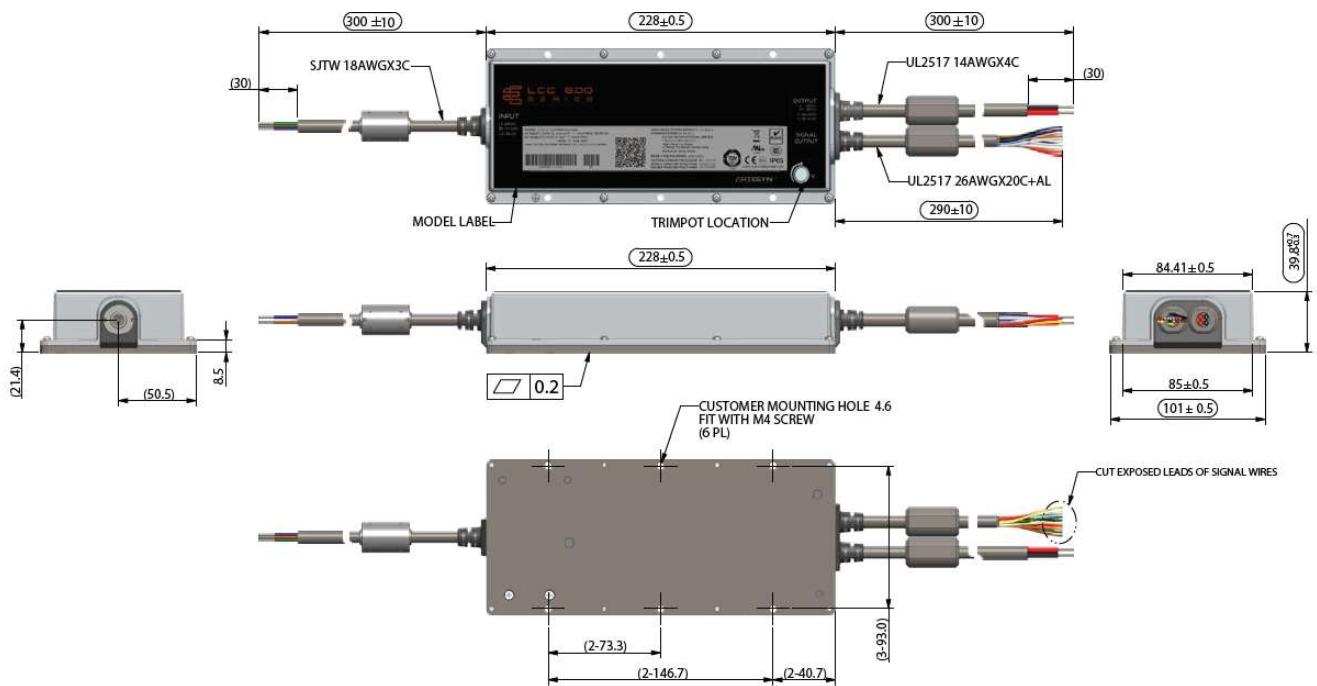

MECHANICAL SPECIFICATIONS

Mechanical Outlines (unit: mm)

“-4PR” Suffix - Right Angle Cables (28, 36, 48 Vdc)

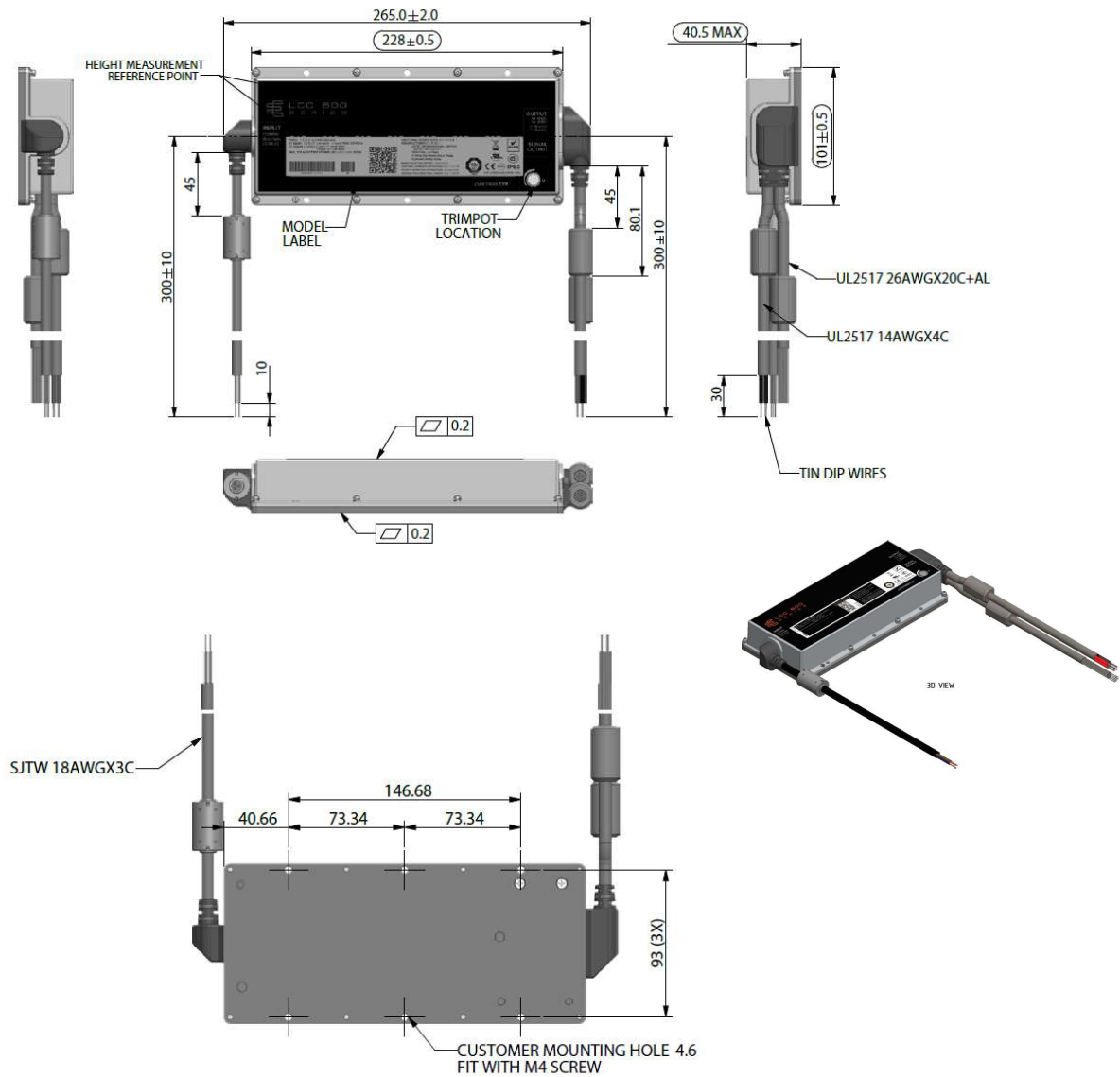

MECHANICAL SPECIFICATIONS

Mechanical Outlines (unit: mm)

“-4P” Suffix (28, 36, 48 Vdc)

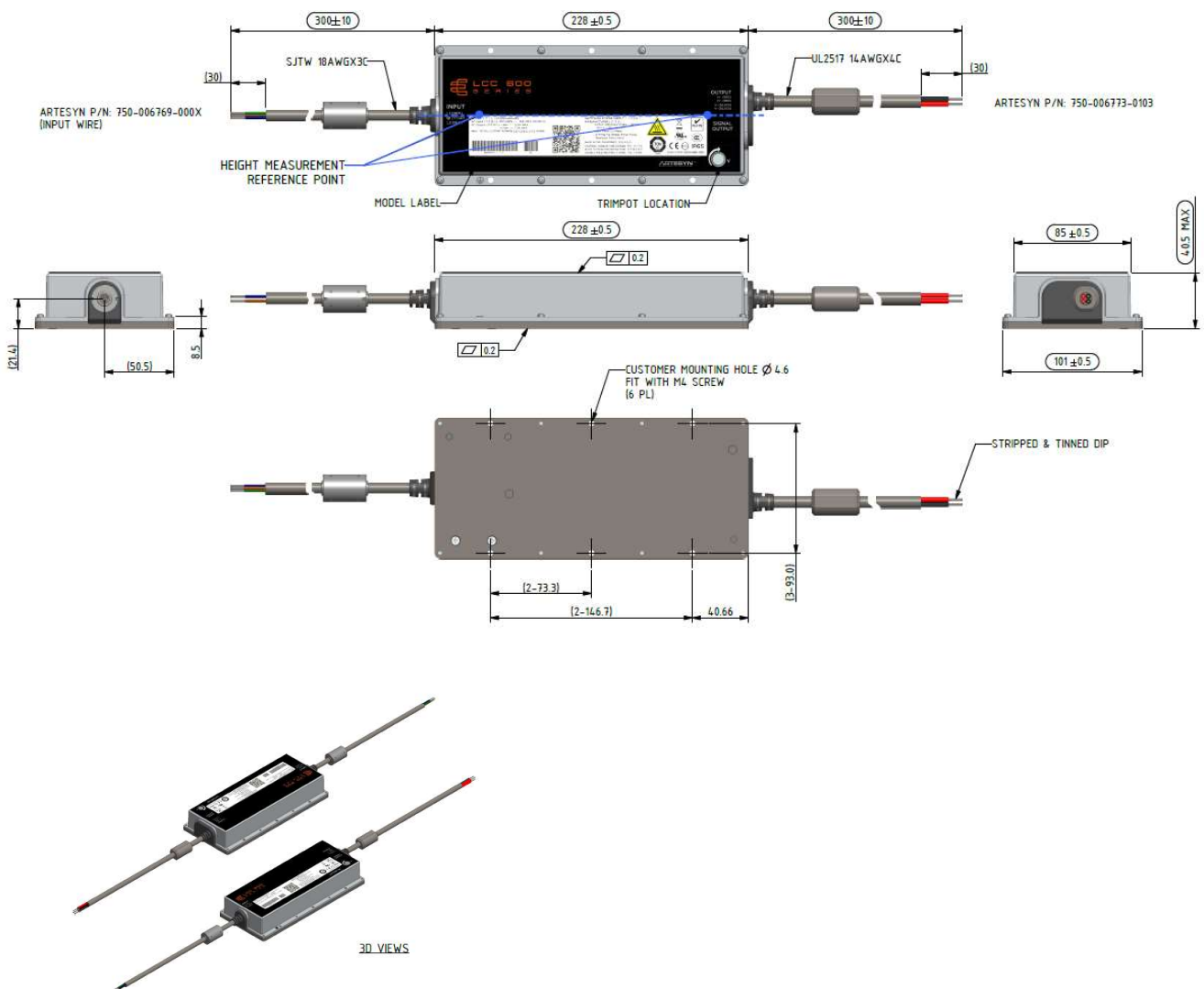

MECHANICAL SPECIFICATIONS

Mechanical Outlines (unit: mm)

Thermal Interface PN: 70-841-031

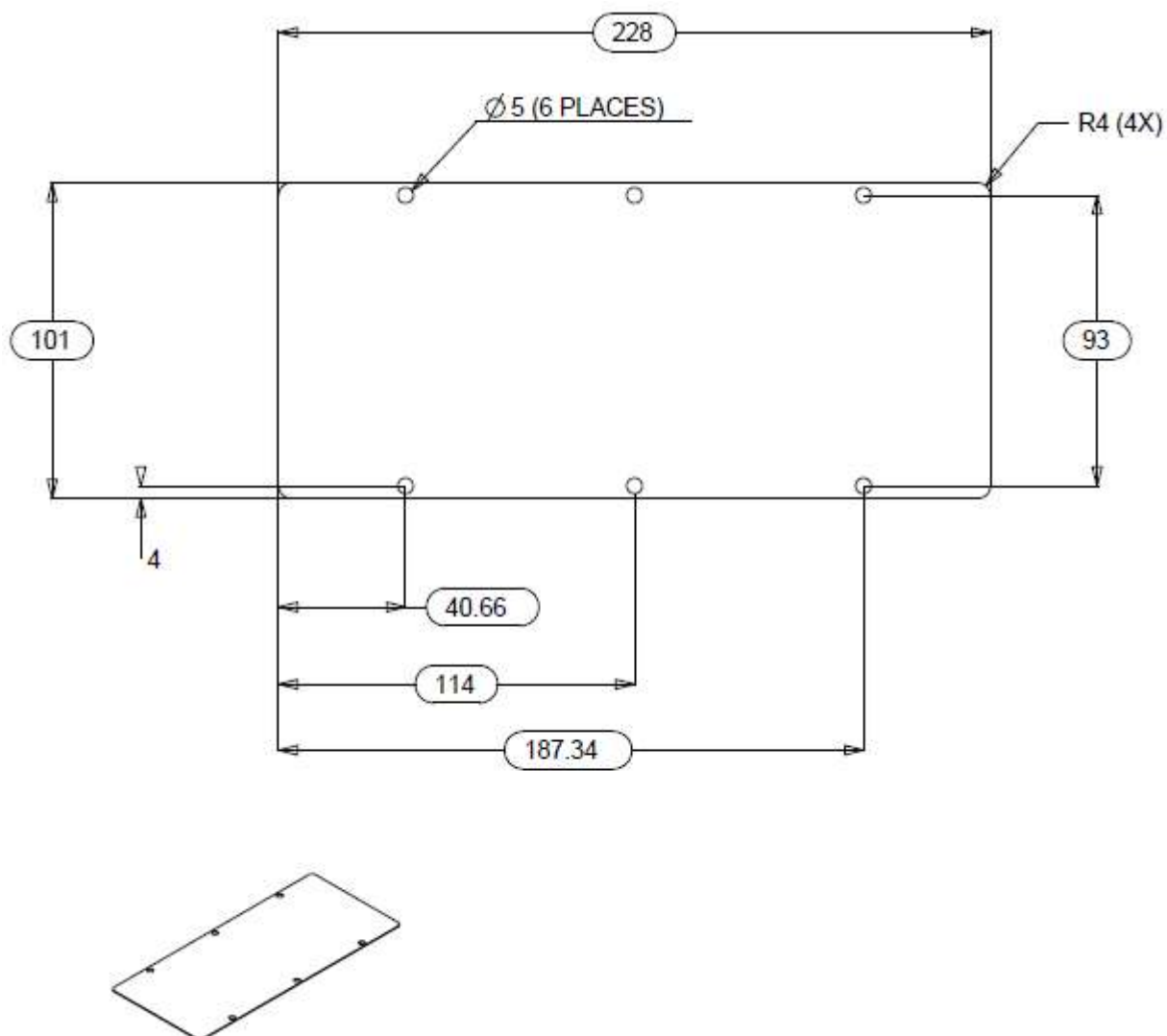

MECHANICAL SPECIFICATIONS

Mechanical Outlines (unit: mm)

Thermal Interface PN: 70-841-031

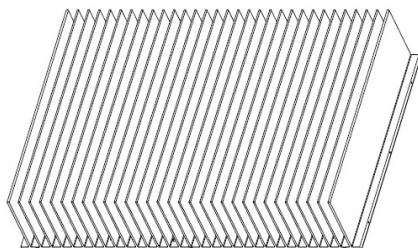
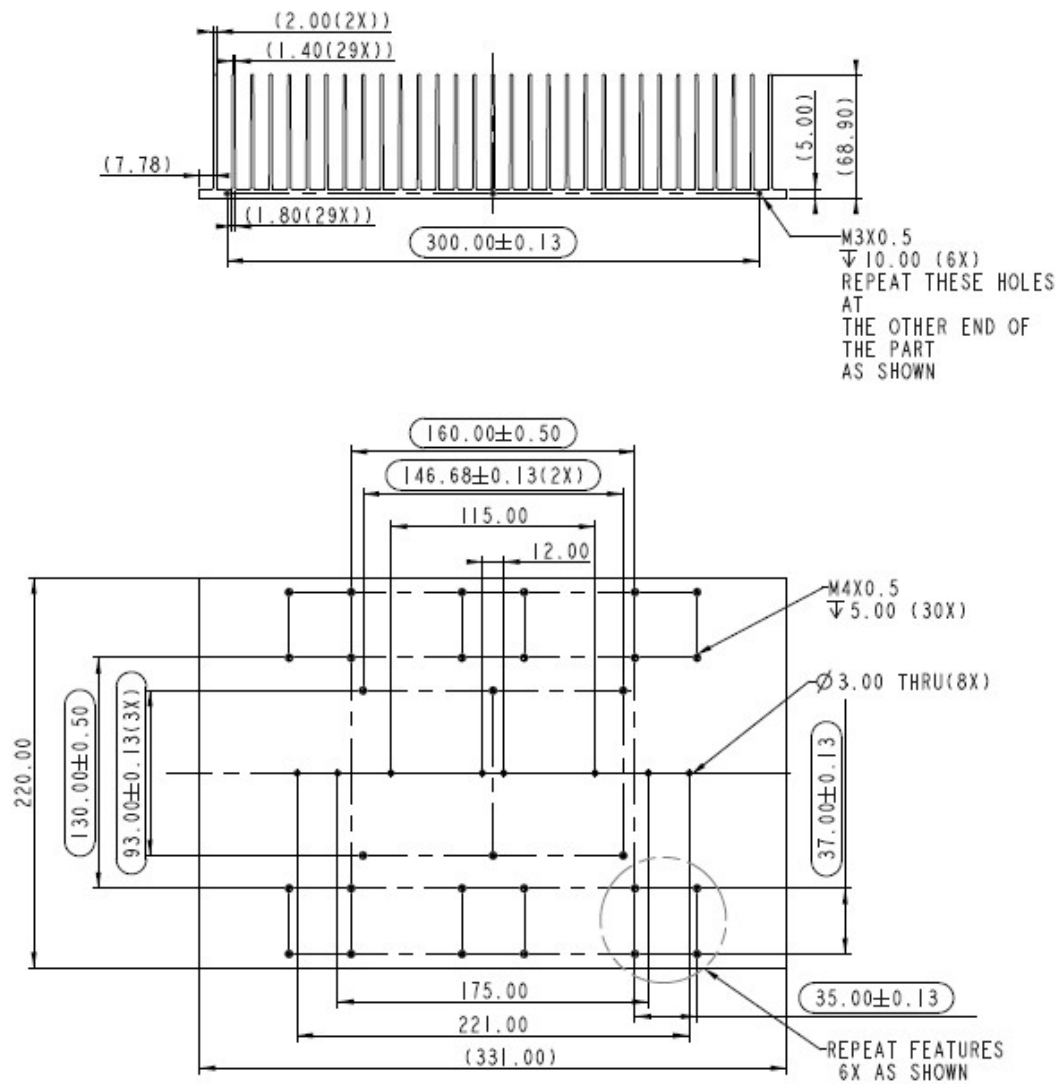

MECHANICAL SPECIFICATIONS

Connector Definitions

AC Input Connector (-9P)

L1 – Live

L2 – Neutral

G – Ground

AC Input Connector (-4P)

Brown – Line

Blue – Neutral

Y/GR – Ground

Output Connector (-9P)

+Vout – Main Output

-Vout – Main Output Return GND

Output Connector (-4P)

Red – Main Output

Black – Main Output Return GND

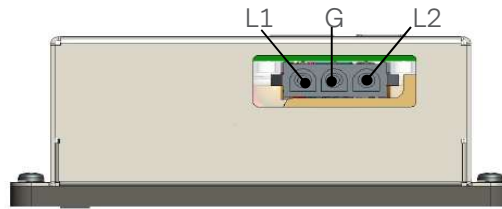

“-9p” Suffix

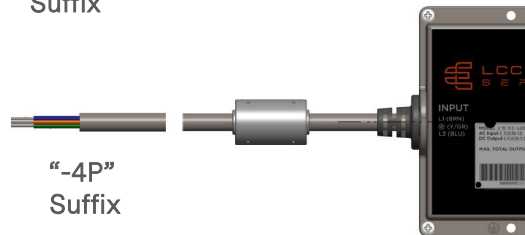

“-4P” Suffix

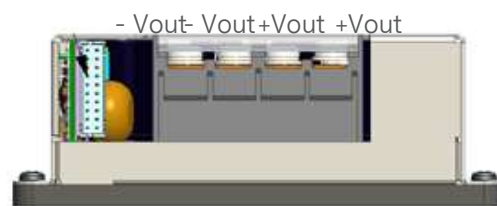

“-9P” Suffix

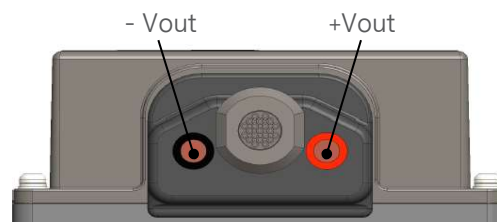

“-4P” Suffix (12Vdc Output)

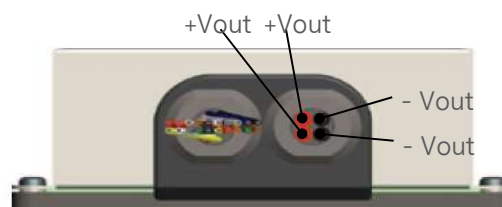

“-4P” Suffix (28Vdc,36Vdc,48Vdc Output)

MECHANICAL SPECIFICATIONS

Pin Assignment

Table 6. Output Signal Connector Pin Assignment				
Signals	Description	Amps per Pin	-9P Suffix J1501 Pin Number ¹	-4P Suffix Wire Color
A2_OUT	EEPROM Address	N/A	1	BLACK
GND	Ground / Ishare Return	N/A	2	BROWN
A1_OUT	EEPROM Address	N/A	3	RED
-VOUT_RS	Remote Sense Return (Main O/P)	N/A	4	ORANGE
ISHARE	Load share voltage	N/A	5	YELLOW
A0_OUT	EEPROM Address	N/A	6	GREEN
SDA	Serial Data Signal(I ² C)	N/A	7	BLUE
SPARE_1/ CC_PROG ¹	Constant Current Level Adjust	N/A	8	VIOLET
SCL	Serial clock Signal (I ² C)	N/A	9	GRAY
+VOUT_RS	Remote Sense (Main O/P)	N/A	10	WHITE
5VSB	5V Standby (1.5A Max)	1.5	11	PINK
SGND	5V Standby Return	1.5	12	LIGHT BLUE
SPARE_2	Spare/Unused Pin	N/A	13	WHITE/VIOLET
G_DCOK_C	Global DC_OK Collector	N/A	14	WHITE/YELLOW
WP	EEPROM Write Protect	N/A	15	WHITE/ORANGE
G_DCOK_E	Global DC_OK Emitter (GND)	N/A	16	WHITE/BLACK
GND	Return GND for O/P Signal and I ² C communication	N/A	17	WHITE/RED
G_ACOK_C	Global AC_OK Collector	N/A	18	WHITE/BROWN
INH_EN	Output Inhibit Enable Pin (turns output off)	N/A	19	WHITE/GREEN
G_ACOK_E	Global AC_OK Emitter (GND)	N/A	20	WHITE/BLUE

Note 1 - Only for LCC600-48U-4PD

-9P Suffix J1501 connector

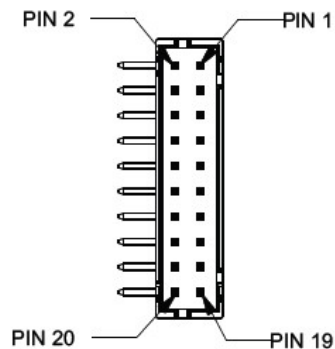

MECHANICAL SPECIFICATIONS

Power / Signal Mating Connectors and Pin Types

“-9P” Suffix (With Safety Cover / Non IP65 Enclosure)

Reference	On Power Supply	Mating Connector or Equivalent
AC Input Connector	Part number: 1-350943-0 Manufacturer: TE Connectivity Co., Ltd.	Part number: 350766-1 (Housing) Manufacturer: TE Connectivity Co., Ltd. Part number: 350536-1 (Contact terminal) Manufacturer: TE Connectivity Co., Ltd. Or equivalent terminal.
J1501	Part number: CI0120P1HD0-LF; Manufacturer: LANDWIN Co., Ltd. Part number: S20B-PHDSS Manufacturer: JST Mfg. Co., Ltd.	Part number: PHDR-20VS (Housing) Manufacturer: JST Mfg. Co., Ltd. Part number: SPHD-001T-P0.5 (contact pins) Manufacturer: JST Mfg. Co., Ltd. Or equivalent terminal.
Output Power connector	4-position Terminal Block (M4 screw / 10mm pitch with plastic cover); 12kgf-cm Torque	Part number: BB-124-08 (19141-0058) Manufacturer: Molex Co., Ltd. Or equivalent ring/spade terminal.

“-9P” Suffix (With Safety Cover / Non IP65 Enclosure)

Reference	Designation / Color	Wire Type / Size
AC Input	Live = Brown Neutral = Blue Ground = Y/GR	SJTW 18AWGX3C; PVC Jacket; 105 °C/300V
DC Output	12Vdc Output +Vout = Red -Vout = Black	6AWG Multi-Strand; PVC Jacket; 105 °C/300V
	28Vdc,36Vdc, 48Vdc Output +Vout = Red +Vout = Red -Vout = Black -Vout = Black	14AWGX4C; PVC Jacket; 105 °C/300V
Control Cable	See Table 6	26AWGX20C+AL; PVC Jacket; 105 °C/300V

MECHANICAL SPECIFICATIONS

Weight

The LCC600 series weight as below,

For “9P” suffix, weight is 3.59 lbs / 1.63kg typical.

For “4P” suffix, weight is 3.99 lbs / 1.81kg typical.

ENVIRONMENTAL SPECIFICATIONS

EMC Immunity

The LCC600 series are designed to meet the following EMC immunity specifications

Table 7. ENVIRONMENTAL SPECIFICATIONS	
Document	Description
EN61000-3-2	Harmonics – Meets Class A at full load condition. – Meets Class C from 50% load to full load
EN61000-3-3	Voltage Fluctuations (Flicker)
IEC/EN 61000-4-2	ESD – +/-8KV contact, Performance criteria A – +/-15kV Air discharge, Performance criteria A
IEC/EN 61000-4-3	RF Field Strength Susceptibility – 80~1000MHz, 1000~2700MHz (1kHz sinewave with 80% AM: 10V/m) – Performance Criteria A
IEC/EN 61000-4-4	Fast Transient – ±0.5kV, ±1.0kV, ±2.0kV for Power Lines and Protective Earth Terminal – Performance Criteria A
IEC/EN 61000-4-5	Surge – Level 3, Criteria A: 2KV CM; 1KV DM for U version – Level 4, Criteria A: 4kV CM; 2kV DM for H version
EN61000-4-6	Levels: – 1kHz sine wave with 80% AM: 3V – 6V In ISM bands – 6V In Amateur radio bands Frequency Range: – 0.15-80 (MHz) – 6.7~6.795, 13.553~13.567, 26.957~27.283, 40.66~40.70 (MHz) – 1.8~2.0, 3.5~4.0, 5.3~5.4, 7.0~7.3, 10.10~10.15, 14.0~14.2, 18.07~18.17, 21.0~21.4, 24.89~24.99, 28.0~29.7, 50.0~54.0 (MHz) – Performance Criteria A
EN61000-4-8	Power Freq Magnetic – Performance Criteria A, Level 4 for Continuous Field, 30A/m
IEC/EN 61000-4-11	Voltage Dips and Interruptions – 30% reduction for 500 mS – Criteria B; – >95% reduction for 10 mS, Criteria A; – >95% reduction for 5000 mS, Criteria C – Hold-up time of 20mS can be met at full load and nominal output voltage
MIL-STD-461F	MIL-STD-461F EMI – For CE101; CE102; CS101; CS114; CS115; CS116 (For U input only) – External EMI filter with P/N ZGLPG-10-02M or ZGLPG-10-02M Type "C" (Zhongguang Hi Tech) required for Mil-STD EMI compliance
EN60601-1-2	Medical EMC Standard
EN55024:1998	Information Technology Equipment-Immunity Characteristics, Limits and Method of Measurements

ENVIRONMENTAL SPECIFICATIONS

Safety Certifications

The LCC600 series are intended for inclusion in other equipment and the installer must ensure that it is in compliance with all the requirements of the end application. This product is only for inclusion by professional installers within other equipment and must not be operated as a standard alone product.

Table 7. Safety Certifications for LCC600 Series Power Supply System		
Standard	Agency	Description
62368-1 2 nd Ed. ANSI ES60601-1 UL 8750 ⁵ CSA-C22.2 No. 250.13	UL + CSA	US and Canada Requirements
62368-1 2 nd Ed. 60601-1 3 rd Ed. EN 61347-1; -2-13	TUV	European Requirements
IEC 60950-1 IEC 62368-1 IEC 60601-1 IEC 61347-1; -2-13	CB Scheme	International Electrotechnical Commission
CE Mark		European Requirements
UKCA Mark		UK Requirements
CHINA CCC Approval		China Requirements

Note 1 - U suffix have both ITE and Medical Safeties. H suffix carries ITE approval only.

Note 2 - LED Lighting approvals apply to all 48 V output variants.

ENVIRONMENTAL SPECIFICATIONS

EMI Emissions

The LCC600 series has been designed to comply with the Class B limits of EMI requirements of EN55022 (FCC Part 15) and CISPR 22 (EN55022) for emissions and relevant sections of EN61000 (IEC 61000) for immunity. The unit was tested at 600W using resistive load. Conditions is 28V or 48V output, 100%Load, 100Vac input, 60Hz.

Conducted Emissions

The applicable standard for conducted emissions is EN55022 (FCC Part 15). Conducted noise can appear as both differential mode and common mode noise currents. Differential mode noise is measured between the two input lines, with the major components occurring at the supply fundamental switching frequency and its harmonics. Common mode noise, a contributor to both radiated emissions and input conducted emissions, is measured between the input lines and system ground and can be broadband in nature.

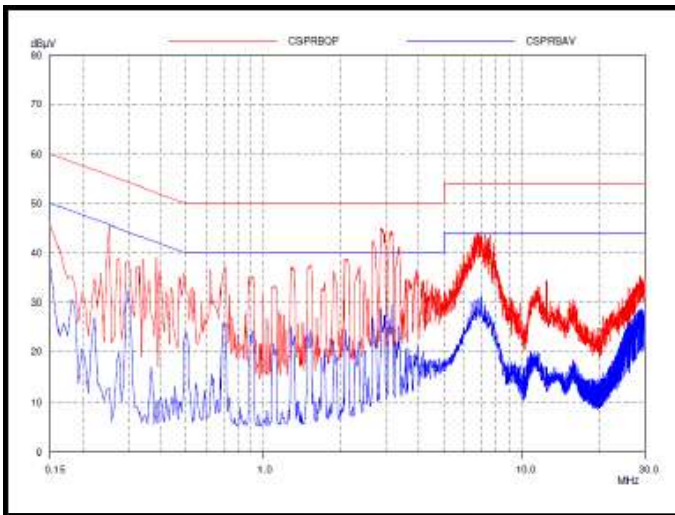

The LCC600 power supplies have internal EMI filters to ensure the convertor’s conducted EMI levels comply with EN55022 (FCC Part 15) Class B and EN55022 (CISPR 22) Class B limits. The EMI measurements are performed with resistive loads at maximum rated loading.

Sample of EN55022 Conducted EMI Measurement at 100Vac input

Note: Red Line refers to Artesyn Quasi Peak margin, which is 6dB below the CISPR international limit. Blue Line refers to the Artesyn Average margin, which is 6dB below the CISPR international limit.

Parameter	Model	Symbol	Min	Typ	Max	Unit
FCC Part 15, class B	All	Margin	-	-	6	dB
EN 60601-1-2: 2001	All	Margin	-	-	6	dB
CISPR 22 (EN55022) class B	All	Margin	-	-	6	dB

ENVIRONMENTAL SPECIFICATIONS

Radiated Emissions

Unlike conducted EMI, radiated EMI performance in a system environment may differ drastically from that in a stand-alone power supply. The shielding effect provided by the system enclosure may bring the EMI level from Class A to Class B. It is thus recommended that radiated EMI be evaluated in a system environment. The applicable standard is EN55022 Class A (FCC Part 15). Testing ac-dc convertors as a stand-alone component to the exact requirements of EN55022 can be difficult, because the standard calls for 1m leads to be attached to the input and outputs and aligned such as to maximize the disturbance. In such a set-up, it is possible to form a perfect dipole antenna that very few ac-dc convertors could pass. However, the standard also states that 'an attempt should be made to maximize the disturbance consistent with the typical application by varying the configuration of the test sample.

ENVIRONMENTAL SPECIFICATIONS

Operating Temperature and Output Power Derating

The LCC600 series power supplies will start and operate within stated specifications at baseplate temperature from -40°C to 85°C under all load conditions.

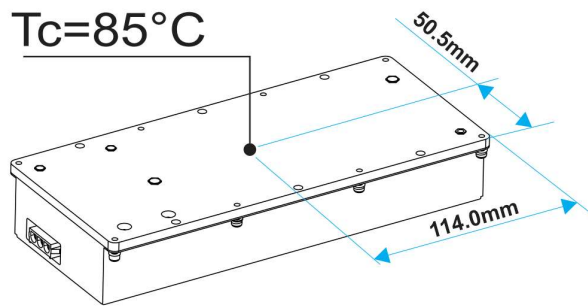

Power Derating vs. Baseplate Temperature

LCC600 series total output power will be derated according to the curve shown below.

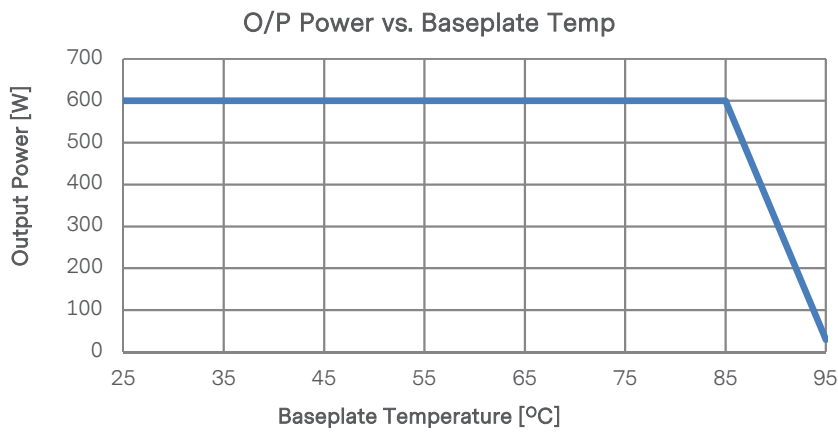

Base Plate Temperature (deg C)	Pout (W)
85	600

ENVIRONMENTAL SPECIFICATIONS

Power Derating vs. Input Voltage

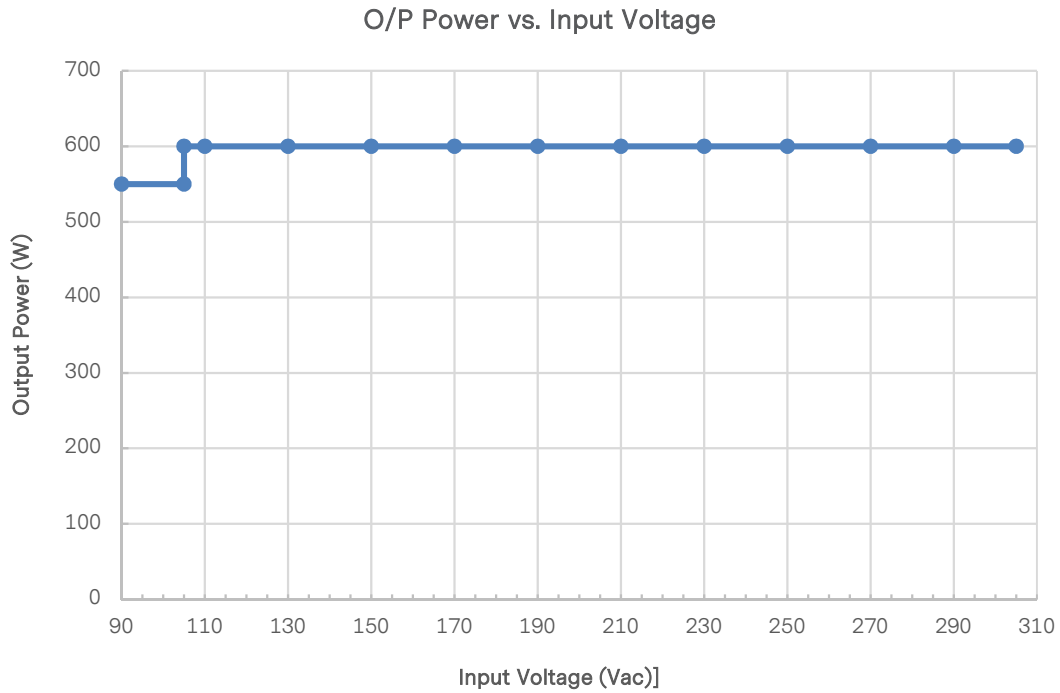

AC Input (Vac)	Pout (W)
90-105	550
105-305	600

ENVIRONMENTAL SPECIFICATIONS

Storage and Shipping Temperature

The LCC600 series power supplies can be stored or shipped at temperatures between -40°C to $+85^{\circ}\text{C}$ and humidity from 10% to 95% non-condensing.

Altitude

The LCC600 series will operate within specifications at altitudes up to 16,402 feet above sea level. The power supply will not be damaged when stored at altitudes of up to 50,000 feet above sea level.

Humidity

The LCC600 series will operate within specifications when subjected to a relative humidity from 10% to 90% non-condensing. The LCC600 series can be stored in a relative humidity from 10% to 95% non-condensing.

Vibration

The LCC600 series power supply will pass the following vibration specifications:

Non-Operating Random Vibration

Acceleration	1.87	gRMS	
Frequency Range	10 to 500	Hz	
Duration	30	mins	
Direction	Three orthogonal axis		
PSD Profile	Frequency(Hz)	Slope(db/oct)	PSD(g^2/Hz)
	10	-	0.009
	200	-2.66	0.009
	500	-	0.004

Non-Operating Random Vibration

Acceleration	0.153	gRMS	
Frequency Range	10 to 500	Hz	
Duration	30	mins	
Direction	Three orthogonal axis		
PSD Profile	Frequency(Hz)	Slope(db/oct)	PSD(g^2/Hz)
	5	11	0.00003
	10-50	-	0.0004
	100	-10	0.00003

Vibration Testing at Packaging Level

Per MIL-STD- 810G 514.5C-1 and 514.5C-15 random vibration exposure.

ENVIRONMENTAL SPECIFICATIONS

Shock

The LCC600 series power supply will pass the following shock specifications:

Non-Operating Half-Sine Shock

Acceleration	30	G
Duration	11	mSec
Pulse	Half-Sine	
Number of Shock	3X each in both positive and negative directions	

Non-Operating Half-Sine Shock
Per MIL-STD-810F 516.5 Procedure I.

POWER AND CONTROL SIGNAL DESCRIPTIONS

AC Input Connector

This connector supplies the AC Mains to the LCC600 series power supply.

L1 = Live
N = Ground
PE = Neutral

Output Connector – Terminal Block

These pins provide the main output for the LCC600 series. The + Main Output (V_O) and the Main Output Return pins are the positive and negative rails, respectively, of the V_O main output of the LCC600 series power supply. The Main Output (V_O) is electrically isolated from the power supply chassis.

+Vout – Positive Main Output
+Vout – Positive Main Output
-Vout – Return GND for Main Output
-Vout – Return GND for Main Output

Control Signals – J1501

The LCC600 series J1501 contains 20 pins control signal header providing analogy control interface, standby power and I²C interface.

A0_Out, A1_Out, A2_Out – (Pin 6, Pin3, Pin1)

Please refer to “COMMUNICATION BUS DESCRIPTIONS” section.

-VOUT_RS, +VOUT_RS – (Pin 4, Pin10)

This remote sense circuit is designed to compensate for a power path drop around the entire loop of 0.5V. These pins should be connected as close to the loading as possible, If left open, the remote sense does not work properly and the voltage level of main output will go lower than the guaranteed spec.

ISHARE – (Pin 5) / Ishare Return (Pin 2)

The main output have active load sharing. The output will share within 10% at full load. All current sharing functions are implemented internal to the power supply by making use of the ISHARE signal. The system connects the ISHARE lines between the power supplies. The supplies must be able to load share with up to 5 power supplies in parallel. The I²C Line should be connected separately when the number of units in parallel is more than 5.

SDA, SCL, GND – (Pin 7, Pin9, Pin17)

Please refer to “COMMUNICATION BUS DESCRIPTIONS” section.

5VSB, SGND – (Pin11, Pin12)

The LCC600 series provides a regulated 5 volt 1.5 amp auxiliary output voltage to power critical circuitry that must remain active regardless of the on/off status of the power supply’s main output. The 5VSB voltage is available whenever a valid AC input voltage is applied to the unit.

POWER AND CONTROL SIGNAL DESCRIPTIONS

G_DCOK_C, G_DCOK_E – (Pin14, Pin16)

G_DCOK_C is a power good signal and is pulled LOW by the power supply to indicate that both the outputs are above the regulation limits of the power supply. When any output voltage falls below regulation limits or when AC power has been removed for a time sufficiently long so that power supply operation is no longer guaranteed, G_DCOK_C will be de-asserted to a HIGH state. Connect 4.7K ohm resistor on G_DCOK_C to PSU's 5V_{SB}.

WP – (Pin15)

Write Protect allows Read/Write operation when connected to GND. When WP pin is connected to 3.3V, the write protection is enabled. This pin is for FRU write protection only.

G_ACOK_C, G_ACOK_E – (Pin18, Pin20)

G-ACOK_C signal is used to indicate presence of AC input to the power supply. A logic "Low" level on this signal will indicate AC input to the power supply is present. A Logic "High" on this signal will indicate a loss of AC input to the power supply. Connect 4.7K ohm resistor on G_ACOK_C to external 5V power supply.

INH_EN – (Pin19)

This signal is used for main output remote turn on/off purpose. PSU main output turns OFF whenever INH_EN is shorted to secondary ground (GND) or connected to Logic low voltage < 0.8V) by external system controller, otherwise the main output remains ON.

INH_EN signal shall be connected to open drain/ collector signal from external system controller, it shall NOT be connected to buffer / driver IC or pull-up resistor up to external 3.3V or 5V supply to avoid external voltage feed and ensure proper operation of PSU.

Note - PSU will not function properly & signal circuit may get damaged if external 3.3V or 5V supply is connected through pull-up resistor or driver IC.

For multiunit / parallel unit configuration, each PSU shall have a either separate open collector signal from system or at-least a signal diode (BAT54) shall be used to separate signals connected to each PSU as shown below.

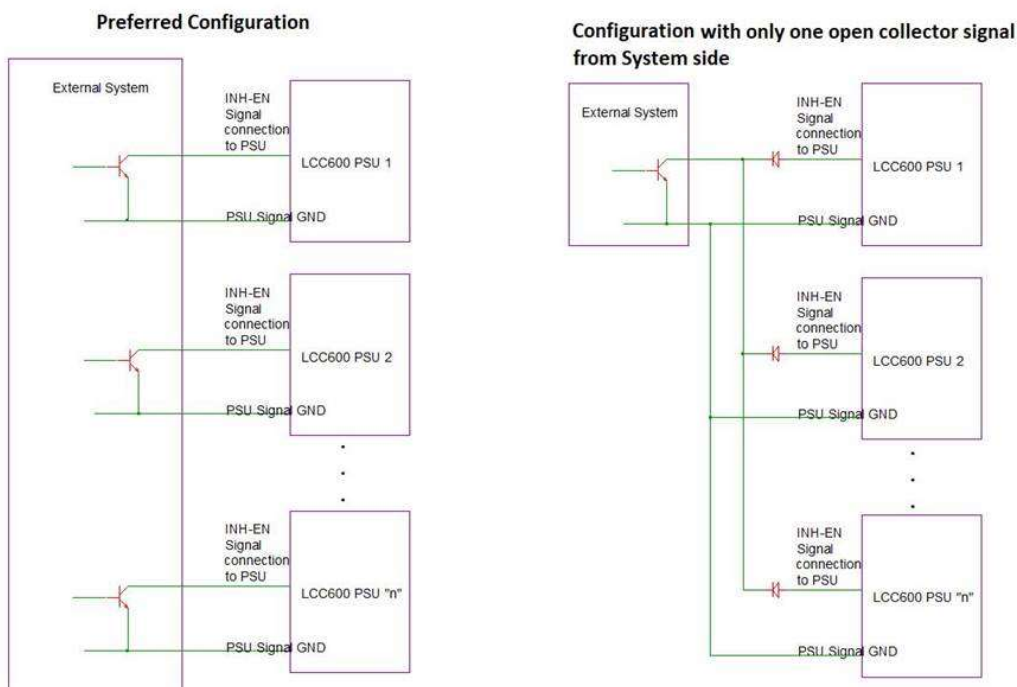

COMMUNICATION BUS DESCRIPTIONS

I²C Bus Signals

The LCC600 series contains enhanced monitor and control functions implemented via the I²C bus. The LCC600 series I²C functionality (PMBus™ and FRU data) can be accessed via the output connector control signals. The communication bus is powered either by the internal 3.3V supply or from an external power source connected to the Standby Output (ie: accessing an unpowered power supply as long as the Standby Output of another power supply connected in parallel is on).

If units are connected in parallel or in redundant mode, the Standby Outputs must be connected together in the system. Otherwise, the I²C bus will not work properly when a unit is inserted into the system without the AC source connected.

Note - PMBus™ functionality can be accessed only when the PSU is powered-up. Guaranteed communication I²C speed is 100KHz.

SDA1, SCL1 (I²C Data and Clock Signals) - (pin7, pin 9)

I²C serial data and clock bus - these pins are internally pulled up to internal 3.3V supply with a 4.75K resistor and 5Vsb with 4.75K resistor. See internal diagram on Page 51 for details. For robustness, recommended to be pulled up by a resistor Rext.

A0, A1, A2 (I²C Address BIT 0, BIT1, BIT2 Signals) - (pin6, pin3, pin1)

These three input pins are the address lines A0, A1 and A2 to indicate the slot position the power supply occupies in the power bay and define the power supply addresses for FRU data and PMBus™ data communication. This allows the system to assign different addresses for each power supply. During I²C communication between system and power supplies, the system will be the master and power supplies will be slave.

They are internally pulled up to internal 3.3V supply with a 2.2K resistor.

PMBus Address

1	0	1	1	A2	A1	A0	W/R
---	---	---	---	----	----	----	-----

FRU Address

1	0	1	0	A2	A1	A0	W/R
---	---	---	---	----	----	----	-----

I²C Bus Communication Interval

The interval between two consecutive I²C communications to the power supply should be at least 50ms to ensure proper monitoring functionality.

I²C Bus Signal Integrity

The noise on the I²C bus (SDA, SCL lines) due to the power supply will be less than 450mV peak-to-peak. This noise measurement should be made with an oscilloscope bandwidth limited to 100MHz.

The noise on the address lines A0 and A1 will be less than 450mV peak-to-peak. This noise measurement should be made at the power supply output connector.

COMMUNICATION BUS DESCRIPTIONS

I²C Bus Internal Implementation, Pull-ups and Bus Capacitances

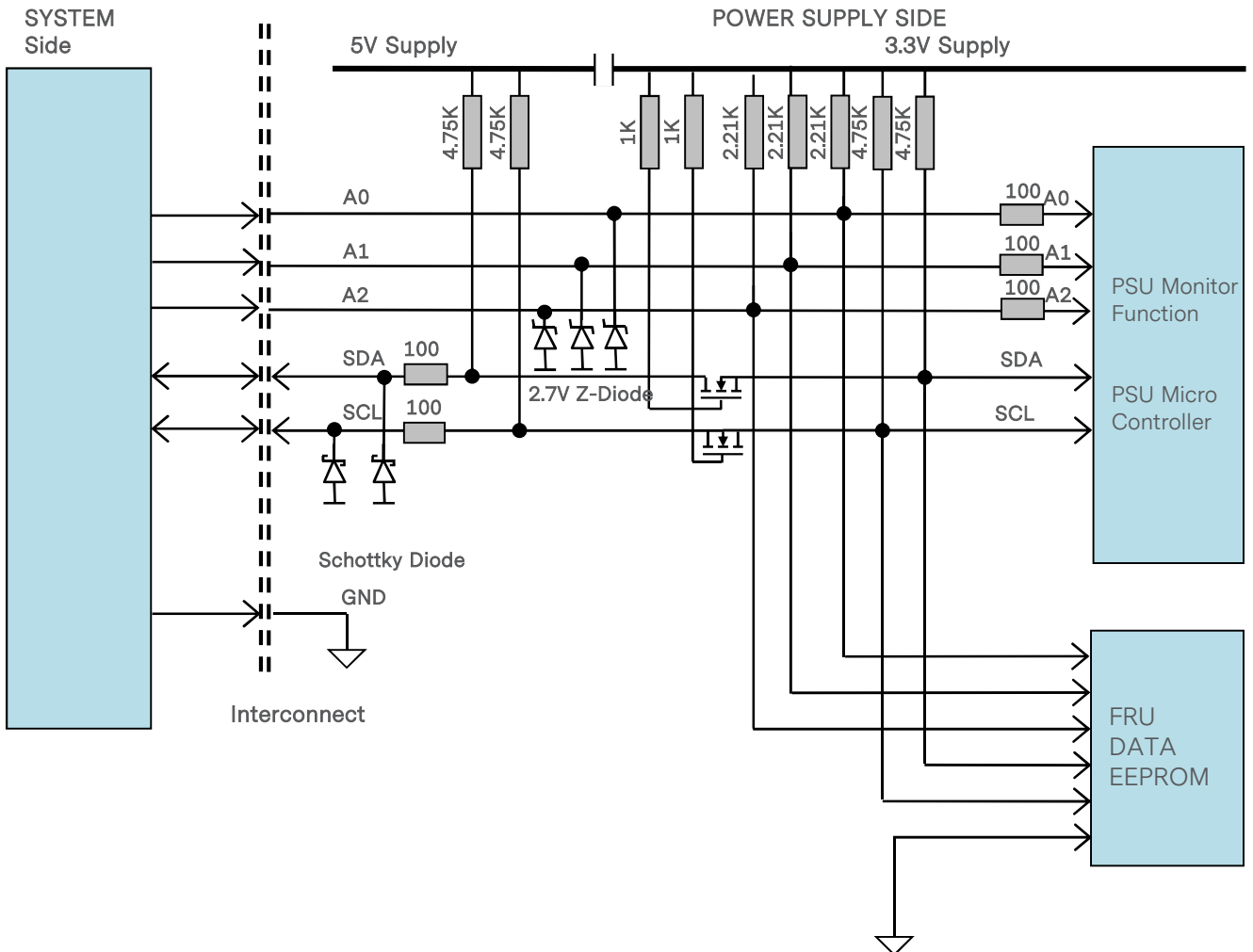

I²C Bus - Recommended external pull-ups

Electrical and interface specifications of I²C signals (referenced to standby output return pin, unless otherwise indicated):

Parameter	Condition	Symbol	Min	Type	Max	Unit
SDA, SCL Internal Pull-up Resistor		R_{int}	-	2.85	-	Kohm
SDA, SCL Internal Bus Capacitance		C_{int}	-	53	-	pF
Recommended External Pull-up Resistor	1 to 5 PSU	R_{ext}	0.75	-	2.2	Kohm

COMMUNICATION BUS DESCRIPTIONS

Logic Levels

LCC600 series power supply I²C communication bus will respond to logic levels as per below:

Logic High: 5.1V nominal (Spec is 2.1V to 5.5V)**

Logic Low: 500mV nominal (Spec is 800mV max)**

**Note - Artesyn 73-769-001 I²C adapter was used.

Timings

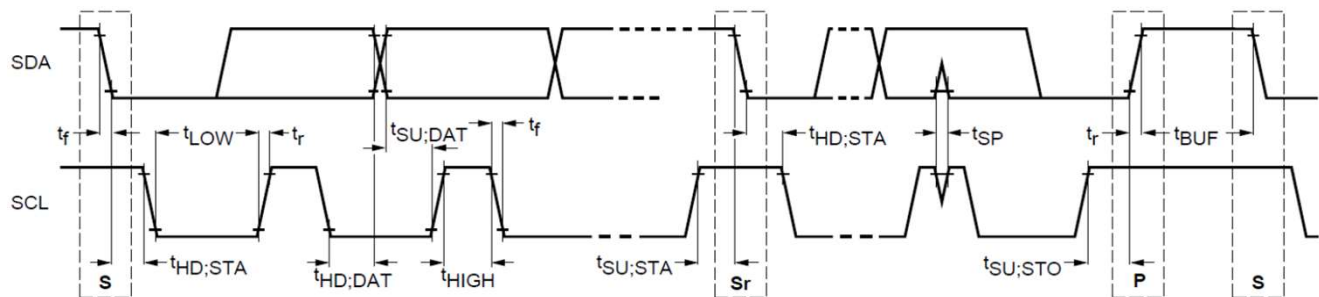

Parameter	Symbol	Standard-Mode Specs		Actual Measured		Unit
		Min	Max			
SCL clock frequency	f_{SCL}	0	100	260		KHz
Hold time (repeated) START condition	$t_{HD;STA}$	4.0	-	4.736		uS
LOW period of SCL clock	t_{LOW}	4.7	-	14.868		uS
HIGH period of SCL clock	t_{HIGH}	4.0	-	4.352		uS
Setup time for repeated START condition	$t_{SU;STA}$	4.7	-	5.566		uS
Data hold time	$t_{HD;DAT}$	0	3.45	0.408		uS
Data setup time	$t_{SU;DAT}$	250	-	921.2		nS
Rise time	t_r	-	1000	SCL = 512	SDA = 560	nS
Fall time	t_f	-	300	SCL = 172	SDA = 126	nS
Setup time for STOP condition	$t_{SU;STO}$	4.0	-	4.282		uS
Bus free time between a STOP and START condition	t_{BUF}	4.7	-	95***		uS

***Note: Artesyn 73-769-001 I²C adapter (USB-to-I²C) and Universal PMBus™ GUI software was used.

COMMUNICATION BUS DESCRIPTIONS

Device Addressing

The LCC600 series will respond to supported commands on the I²C bus that are addressed according to pins A0, A1 and A2 of output connector.

Address pins are held HIGH by default via pulled up to internal 3.3V supply with a 2k resistor. To set the address as “0”, the corresponding address line should be pulled down to logic ground level. Below tables show the address of the power supply with A0, A1 and A2 pins set to either “0” or “1”:

PSU Slot	Slot ID Bits			PMBus™ Address	EEPROM (FRU) Address
	A2	A1	A0		
1	0	0	0	B0	A0
2	0	0	1	B2	A2
3	0	1	0	B4	A4
4	0	1	1	B6	A6
5	1	0	0	B8	A8
6	1	0	1	BA	AA
7	1	1	0	BC	AC
8	1	1	1	BE*	AE

* Default PMBus™ address when A0 and A1 and A2 are left open

COMMUNICATION BUS DESCRIPTIONS

FRU (EEPROM) Data

The FRU (Field Replaceable Unit) data format compliant with the Intel IPMI v1.0 specification.

The LCC600 series uses 1 page of EEPROM for FRU purpose. A page of EEPROM contains up to 256 byte-sized data locations.

Where: OFFSET -The OFFSET denotes the address in decimal format of a particular data byte within LCC600 series P EEPROM.

VALUE -The VALUE details data written to a particular memory location of the EEPROM.

DEFINITION -The contents DEFINITION refers to the definition of a particular data byte.

LCC600-12U-9P FRU (EEPROM) Data:

OFFSET		DEFINITION (REMARKS)	SPEC VALUE	
(DEC)	(HEX)		(DEC)	(HEX)
COMMON HEADER, 8 BYTES				
0	00	FORMAT VERSION NUMBER (Common Header) 7:4 - Reserved, write as 0000b 3:0 - Format Version Number = 1h for this specification	1	01
1	01	INTERNAL USE AREA OFFSET	27	1B
2	02	CHASSIS INFO AREA OFFSET	1	01
3	03	BOARD INFO AREA OFFSET	0	00
4	04	PRODUCT INFO AREA OFFSET	5	05
5	05	MULTI RECORD AREA OFFSET	13	0D
6	06	PAD (reserved) Default value is 0.	0	00
7	07	ZERO CHECK SUM (256 - (Sum of bytes 0 to 6))	209	D1
CHASSIS INFO AREA(32 BYTES)				
8	08	FORMAT VERSION NUMBER 7:4 - Reserved, write as 0000b 3:0 - Format Version Number = 1h for this specification	1	01
9	09	CHASSIS INFO AREA LENGTH in multiple of 8 bytes	4	04
10	0A	CHASSIS TYPE (Default value is 0.)	0	00
11	0B	CHASSIS PART NUMBER Type/Length CAh (if used) Type = "ASCII+LATIN1" = (11)b Length = 10 Bytes = (001010)b	193	C1
12	0C	Reserved	0	00
13	0D	Reserved	0	00
14	0E	Reserved	0	00
15	0F	Reserved	0	00
16	10	Reserved	0	00
17	11	Reserved	0	00
18	12	Reserved	0	00
19	13	Reserved	0	00
20	14	Reserved	0	00
21	15	Reserved	0	00
22	16	Reserved	0	00
23	17	Reserved	0	00
24	18	Reserved	0	00
25	19	Reserved	0	00
26	1A	Reserved	0	00
27	1B	Reserved	0	00
28	1C	Reserved	0	00
29	1D	Reserved	0	00
30	1E	Reserved	0	00

COMMUNICATION BUS DESCRIPTIONS

LCC600-12U-9P FRU (EEPROM) Data:

OFFSET		DEFINITION (REMARKS)	SPEC VALUE	
(DEC)	(HEX)		(DEC)	(HEX)
31	1F	Reserved	0	00
32	20	Reserved	0	00
33	21	Reserved	0	00
34	22	Reserved	0	00
35	23	Reserved	0	00
36	24	Reserved	0	00
37	25	Reserved	0	00
38	26	END TAG	0	00
39	27	ZERO CHECK SUM (256 – (Sum of bytes offset 8h to 26h))	58	3A
PRODUCT INFORMATION AREA				
40	28	FORMAT VERSION NUMBER (Product Info Area) 7:4 – Reserved, write as 0000b 3:0 – Format Version Number =1h for this specification	1	01
41	29	PRODUCT INFO AREA LENGTH (In multiples of 8 bytes)	8	08
42	2A	Language (English)	25	19
43	2B	MANUFACTURER NAME TYPE / LENGTH 7:6 – (11)b, 8-Bit ASCII + Latin 1, 5:0 – (000111)b, 7-Byte Allocation	199	C7
		MANUFACTURER'S NAME 7 byte sequence "ARTESYN"		
44	2C	"A" = 41h	65	41
45	2D	"R" = 52h	82	52
46	2E	"T" = 54h	84	54
47	2F	"E" = 45h	69	45
48	30	"S" = 53h	83	53
49	31	"Y" = 59h	89	59
50	32	"N" = 4Eh	78	4E
51	33	PRODUCT NAME Type/Length (CDh) Type = "ASCII+LATIN1" = (11)b; Length = 13 Bytes = (001101)b	206	CE
		PRODUCT NAME BYTES (14 Byte sequence) "LCC600-12U-9P"		
52	34	"L" = 4Ch	76	4C
53	35	"C" = 43h	67	43
54	36	"C" = 43h	67	43
55	37	"6" = 36h	54	36
56	38	"O" = 30h	48	30
57	39	"O" = 30h	48	30
58	3A	"-" = 2Dh	45	2D
59	3B	"1" = 31h	49	31
60	3C	"2" = 32h	50	32
61	3D	"U" = 55h	85	55
62	3E	"-" = 2Dh	45	2D
63	3F	"9" = 39h	57	39
64	40	"P" = 50h	80	50
65	41	Space = 20h	32	20

COMMUNICATION BUS DESCRIPTIONS

LCC600-12U-9P FRU (EEPROM) Data:

OFFSET		DEFINITION (REMARKS)	SPEC VALUE	
(DEC)	(HEX)		(DEC)	(HEX)
66	42	PRODUCT PART/MODEL NUMBER Type/Length (Cah) Type = "ASCII+LATIN1" = (11)b Length = 10 Bytes = (001010)b	202	CA
67	43	Reserved	0	00
68	44	Reserved	0	00
69	45	Reserved	0	00
70	46	Reserved	0	00
71	47	Reserved	0	00
72	48	Reserved	0	00
73	49	Reserved	0	00
74	4A	Reserved	0	00
75	4B	Reserved	0	00
76	4C	Reserved	0	00
77	4D	PRODUCT VERSION NUMBER Type/Length (C2h) Type = "ASCII+LATIN1" = (11)b Length = 2 bytes = (000010)b	194	C2
		PRODUCT VERSION NUMBER BYTES Refer to BOM TLA for latest revision		
78	4E	"A"	65	41
79	4F	"A"	65	41
80	50	PRODUCT SERIAL NUMBER Type/Length Type = "ASCII+LATIN1" = (11)b Length = 13 bytes = (001101)b	205	CD
		PRODUCT SERIAL NUMBER BYTES Model ID = "L477"		
81	51	"L" = 4Ch	76	4C
82	52	"4" = 34h	52	34
83	53	"7" = 37h	55	37
84	54	"7" = 37h	55	37
		MANUFACTURING YEAR AND WEEK CODE (PER UNIT)		
85	55	"W"	87	57
86	56	"W"	87	57
87	57	UNIQUE SERIAL NUMBER (PER UNIT)	83	53
88	58	"SSSS"	83	53
89	59	In Decimal = 083, 083, 083, 083	83	53
90	5A	In Hex = 53H, 53H, 53H, 53H	83	53
		MODEL REVISION (PER UNIT) Artesyn Model Rev, See Latest Model Rev in BOM TLA for latest revision		
91	5B	"A"	65	41
92	5C	"A"	65	41
93	5D	"P" = 50h, (For Laguna, Philippines) MANUFACTURING LOCATION	90	50
94	5E	End Tag In Decimal: 193 In Hex: 0C1H	193	C1
95	5F	Reserved	0	00
96	60	Reserved	0	00
97	61	Reserved	0	00
98	62	Reserved	0	00
99	63	Reserved	0	00
100	64	Reserved	0	00
101	65	Reserved	0	00
102	66	Reserved	0	00
103	67	Zero Check Sum (256-(Sum of bytes 12H to 67h) (PER UNIT)		

COMMUNICATION BUS DESCRIPTIONS

LCC600-12U-9P FRU (EEPROM) Data:

OFFSET		DEFINITION (REMARKS)	SPEC VALUE	
(DEC)	(HEX)		(DEC)	(HEX)
MULTI RECORD AREA				
104	68	Power Supply Record Header (72 Bytes) Record Type ID (0x00 = Power Supply Information)	0	00
105	69	3-0: (0010)b, Record Format Version	2	02
106	6A	Record Length: 24 Bytes	24	18
107	6B	Record Checksum (Zero Checksum From 109d To 132d)	197	C5
108	6C	Header Checksum (Zero Checksum From 104d To 107d)	33	21
POWER SUPPLY RECORD				
109	6D	Overall Capacity of the Power Supply, 15-12: (0000)b, Reserved	88	58
110	6E	11-0: (000111001000)b, 600W = 0258H	2	02
111	6F	15-12: (0000)b, Reserved	138	8A
112	70	11-0: (001000011100)b, 650W = 028AH	2	02
113	71	Inrush Current (Amps)	25	19
114	72	Inrush Interval, 200mS	200	C8
115	73	Low End Input Voltage Range 1(10mV)	40	28
116	74	(90V / 10mV) 9000 = 2312H, 2 Bytes Sequence	35	23
117	75	High End Input Voltage Range 1(10mV)	32	20
118	76	(264V/10mV) 26400= 6720H, 2 Bytes Sequence	103	67
119	77	Low End Input Voltage Range 2(10mV)	0	00
120	78	Not Applicable (Auto switch)	0	00
121	79	High End Input Voltage Range 2(10mV)	0	00
122	7A	Not Applicable (Auto switch)	0	00
123	7B	Low End Input Frequency Range, 47Hz = 2FH	47	2F
124	7C	Low End Input Frequency Range, 63Hz = 3FH	63	3F
125	7D	AC Dropout Tolerance in ms, 20mS= 14H	20	14
126	7E	Binary Flags,	38	26
127	7F	15-11: (10100)b, Hold up Time in Seconds = 14H	88	58
128	80	10-0: (01001011000)b, Peak Capacity in Watts =258H	162	A2
129	81	Byte 1 : Bits7-4 ; Voltage 1 Bits3-0 : Voltage 2	0	00
130	82	Byte 2 and Byte 3: Total Combined Wattage	0	00
131	83	Stored with LSB first then MSB. Not Applicable	0	00
132	84	Predictive Fail Tachometer Lower Threshold, Not applicable	0	00
12V DC OUTPUT RECORD HEADER				
133	85	Record Type ID (0x01 = DC Output)	1	01
134	86	End Of List/Record Format Version Number	2	02
135	87	Record Length: 13 Bytes	13	0D

COMMUNICATION BUS DESCRIPTIONS

LCC600-12U-9P FRU (EEPROM) Data:

OFFSET		DEFINITION	SPEC VALUE	
(DEC)	(HEX)	(REMARKS)	(DEC)	(HEX)
136	88	Record Checksum (Zero Checksum From 138d To 150d)	163	A3
137	89	Header Checksum (Zero Checksum From 133d To 136d)	77	4D
12V OUTPUT RECORD				
138	8A	Output Information, 001 = 01H, +12V Output Information	1	01
139	8B	Nominal Voltage	176	B0
140	8C	12.00V = 1200 (x10mV) = 04B0H	4	04
141	8D	Maximum Negative Voltage Deviation	176	B0
142	8E	12.00V = 1200 (x10mV) = 04B0H, 2 Bytes Sequence	4	04
143	8F	Maximum Positive Voltage Deviation	220	DC
144	90	15V = 1500 (x10mV) = 05DCH, 2 Bytes Sequence	5	05
145	91	Ripple and Noise pk-pk (mV)	120	78
146	92	120mV (x 1mV)= 0078H, 2 Bytes Sequence	0	00
147	93	Minimum Current Draw (10mA),	0	00
148	94	0000 = 0000H, 2 Bytes Sequence	0	00
149	95	Minimum Current Draw (10mA), 0000 = 0000H	136	88
150	96	50.0A = 5000 (x10mA) = 1388H	19	13
5VSB OUTPUT RECORD HEADER				
151	97	Record type ID (0x01 = DC Output)	1	01
152	98	End of List /Record Format Version Number for 5VSB Output Record	2	02
153	99	Record Length: 13 Bytes	13	0D
154	9A	Record CHECKSUM of 5VSB Output Record (Zero CHECKSUM)	214	D6
155	9B	(256-(sum of bytes 156 to 168) Header CHECKSUM of 5VSB Output Record Header (Zero CHECKSUM) (256-(sum of bytes 151 to 154))	26	1A
156	9C	Output Information, 002 = 02H Bit 7: Standby Information = 1B Bits 6-4: Reserved, Write as 000B Bits 3-0: Output Number 2 = 010B	130	82
157	9D	Nominal Voltage	244	F4
158	9E	5.00V = 2500(x10mA) = 01F4H, 2 Bytes Sequence	1	01
159	9F	Maximum Negative Voltage Deviation	219	DB
160	A0	4.75V = 525 (x10mV) = 01DBH, 2 Bytes Sequence	1	01
161	A1	Maximum Positive Voltage Deviation	13	0D
162	A2	5.25V = 525(x10mA) = 020DH, 2 Bytes Sequence	2	02
163	A3	Ripple And Noise pk-pk (mV)	50	32
164	A4	50mV = 0032H, 2 Bytes Sequence	0	00
165	A5	Minimum Current Draw (10mA)	0	00
166	A6	0000 = 000AH, 2 Bytes Sequence	0	00
167	A7	Maximum Current Draw (10mA), (6.0A / 10mA) 600 = 0258H	150	96
168	A8	0150 = 0096H, 2 Bytes Sequence	0	00

COMMUNICATION BUS DESCRIPTIONS

LCC600-12U-9P FRU (EEPROM) Data:

OFFSET		DEFINITION (REMARKS)	SPEC VALUE	
(DEC)	(HEX)		(DEC)	(HEX)
OEM RECORD HEADER				
169	A9	Record type = C0H for OEM Record	192	C0
170	AA	End of List /Record Format Version Number for 5V _{SB} output Record	130	82
171	AB	Record Length of OEM Record	42	2A
172	AC	Record CHECKSUM of OEM Record (Zero CHECKSUM)	0	00
173	AD	Header CHECKSUM of OEM Record Header (Zero CHECKSUM) (256-(sum of bytes 169 to 172))	148	94
OEM RECORD				
174	AE	Manufacturer ID (3 bytes, Default is 0)	0	00
175	AF	RESERVED	0	00
176	B0	RESERVED	0	00
177	B1	RESERVED	0	00
178	B2	RESERVED	0	00
179	B3	RESERVED	0	00
180	B4	RESERVED	0	00
181	B5	RESERVED	0	00
182	B6	RESERVED	0	00
183	B7	RESERVED	0	00
184	B8	RESERVED	0	00
185	B9	RESERVED	0	00
186	BA	RESERVED	0	00
187	BB	RESERVED	0	00
188	BC	RESERVED	0	00
189	BD	RESERVED	0	00
190	BE	RESERVED	0	00
191	BF	RESERVED	0	00
192	C0	RESERVED	0	00
193	C1	RESERVED	0	00
194	C2	RESERVED	0	00
195	C3	RESERVED	0	00
196	C4	RESERVED	0	00
197	C5	RESERVED	0	00
198	C6	RESERVED	0	00
199	C7	RESERVED	0	00
200	C8	RESERVED	0	00
201	C9	RESERVED	0	00
202	CA	RESERVED	0	00
203	CB	RESERVED	0	00
204	CC	RESERVED	0	00
205	CD	RESERVED	0	00
206	CE	RESERVED	0	00
207	CF	RESERVED	0	00
208	D0	RESERVED	0	00
209	D1	RESERVED	0	00
210	D2	RESERVED	0	00
211	D3	RESERVED	0	00
212	D4	RESERVED	0	00
213	D5	RESERVED	0	00
214	D6	RESERVED	0	00
215	D7	RESERVED	0	00

COMMUNICATION BUS DESCRIPTIONS

LCC600-12H-9P FRU (EEPROM) Data:

OFFSET		DEFINITION (REMARKS)	SPEC VALUE	
(DEC)	(HEX)		(DEC)	(HEX)
COMMON HEADER, 8 BYTES				
0	00	FORMAT VERSION NUMBER (Common Header) 7:4 - Reserved, write as 0000b 3:0 - Format Version Number = 1h for this specification	1	01
1	01	INTERNAL USE AREA OFFSET	27	1B
2	02	CHASSIS INFO AREA OFFSET	1	01
3	03	BOARD INFO AREA OFFSET	0	00
4	04	PRODUCT INFO AREA OFFSET	5	05
5	05	MULTI RECORD AREA OFFSET	13	0D
6	06	PAD (reserved) Default value is 0.	0	00
7	07	ZERO CHECK SUM (256 – (Sum of bytes 0 to 6))	209	D1
CHASSIS INFO AREA(32 BYTES)				
8	08	FORMAT VERSION NUMBER 7:4 - Reserved, write as 0000b 3:0 - Format Version Number = 1h for this specification	1	01
9	09	CHASSIS INFO AREA LENGTH in multiple of 8 bytes	4	04
10	0A	CHASSIS TYPE (Default value is 0.)	0	00
11	0B	CHASSIS PART NUMBER Type/Length CAh (if used) Type = "ASCII+LATIN1" = (11)b Length = 10 Bytes = (001010)b	193	C1
12	0C	Reserved	0	00
13	0D	Reserved	0	00
14	0E	Reserved	0	00
15	0F	Reserved	0	00
16	10	Reserved	0	00
17	11	Reserved	0	00
18	12	Reserved	0	00
19	13	Reserved	0	00
20	14	Reserved	0	00
21	15	Reserved	0	00
22	16	Reserved	0	00
23	17	Reserved	0	00
24	18	Reserved	0	00
25	19	Reserved	0	00
26	1A	Reserved	0	00
27	1B	Reserved	0	00
28	1C	Reserved	0	00
29	1D	Reserved	0	00
30	1E	Reserved	0	00

COMMUNICATION BUS DESCRIPTIONS

LCC600-12H-9P FRU (EEPROM) Data:

OFFSET		DEFINITION (REMARKS)	SPEC VALUE	
(DEC)	(HEX)		(DEC)	(HEX)
31	1F	Reserved	0	00
32	20	Reserved	0	00
33	21	Reserved	0	00
34	22	Reserved	0	00
35	23	Reserved	0	00
36	24	Reserved	0	00
37	25	Reserved	0	00
38	26	END TAG	0	00
39	27	ZERO CHECK SUM (256 – (Sum of bytes offset 8h to 26h))	58	3A
PRODUCT INFORMATION AREA				
40	28	FORMAT VERSION NUMBER (Product Info Area) 7:4 – Reserved, write as 0000b 3:0 – Format Version Number =1h for this specification	1	01
41	29	PRODUCT INFO AREA LENGTH (In multiples of 8 bytes)	8	08
42	2A	Language (English)	25	19
43	2B	MANUFACTURER NAME TYPE / LENGTH 7:6 – (11)b, 8-Bit ASCII + Latin 1, 5:0 – (000111)b, 7-Byte Allocation	199	C7
		MANUFACTURER'S NAME 7 byte sequence "ARTESYN"		
44	2C	"A" = 41h	65	41
45	2D	"R" = 52h	82	52
46	2E	"T" = 54h	84	54
47	2F	"E" = 45h	69	45
48	30	"S" = 53h	83	53
49	31	"Y" = 59h	89	59
50	32	"N" = 4Eh	78	4E
51	33	PRODUCT NAME Type/Length (CDh) Type = "ASCII+LATIN1" = (11)b; Length = 13 Bytes = (001101)b	206	CE
		PRODUCT NAME BYTES (14 Byte sequence) "LCC600-12H-9P"		
52	34	"L" = 4Ch	76	4C
53	35	"C" = 43h	67	43
54	36	"C" = 43h	67	43
55	37	"6" = 36h	54	36
56	38	"O" = 30h	48	30
57	39	"O" = 30h	48	30
58	3A	"-" = 2Dh	45	2D
59	3B	"1" = 31h	49	31
60	3C	"2" = 32h	50	32
61	3D	"H" = 55h	85	48
62	3E	"-" = 2Dh	45	2D
63	3F	"9" = 39h	57	39
64	40	"P" = 50h	80	50
65	41	Space = 20h	32	20

COMMUNICATION BUS DESCRIPTIONS

LCC600-12H-9P FRU (EEPROM) Data:

OFFSET		DEFINITION	SPEC VALUE	
(DEC)	(HEX)	(REMARKS)	(DEC)	(HEX)
66	42	PRODUCT PART/MODEL NUMBER Type/Length (Cah) Type = "ASCII+LATIN1" = (11)b Length = 10 Bytes = (001010)b	202	CA
67	43	Reserved	0	00
68	44	Reserved	0	00
69	45	Reserved	0	00
70	46	Reserved	0	00
71	47	Reserved	0	00
72	48	Reserved	0	00
73	49	Reserved	0	00
74	4A	Reserved	0	00
75	4B	Reserved	0	00
76	4C	Reserved	0	00
77	4D	PRODUCT VERSION NUMBER Type/Length (C2h) Type = "ASCII+LATIN1" = (11)b Length = 2 bytes = (000010)b	194	C2
		PRODUCT VERSION NUMBER BYTES Refer to BOM TLA for latest revision		
78	4E	"A"	65	41
79	4F	"A"	65	41
80	50	PRODUCT SERIAL NUMBER Type/Length Type = "ASCII+LATIN1" = (11)b Length = 13 bytes = (001101)b	205	CD
		PRODUCT SERIAL NUMBER BYTES Model ID = "L480"		
81	51	"L" = 4Ch	76	4C
82	52	"4" = 34h	52	34
83	53	"8" = 38h	55	38
84	54	"0" = 30h	56	30
		MANUFACTURING YEAR AND WEEK CODE (PER UNIT)		
85	55	"W"	87	57
86	56	"W"	87	57
87	57	UNIQUE SERIAL NUMBER (PER UNIT) "SSSS"	83	53
88	58	In Decimal = 083, 083, 083, 083	83	53
89	59	In Hex = 53H, 53H, 53H, 53H	83	53
90	5A	In Hex = 53H, 53H, 53H, 53H	83	53
		MODEL REVISION (PER UNIT) Artesyn Model Rev, See Latest Model Rev in BOM TLA for latest revision		
91	5B	"A"	65	41
92	5C	"A"	65	41
93	5D	"P" = 50h, (For Laguna, Philippines) MANUFACTURING LOCATION	90	50
94	5E	End Tag In Decimal: 193 In Hex: 0C1H	193	C1
95	5F	Reserved	0	00
96	60	Reserved	0	00
97	61	Reserved	0	00
98	62	Reserved	0	00
99	63	Reserved	0	00
100	64	Reserved	0	00
101	65	Reserved	0	00
102	66	Reserved	0	00
103	67	Zero Check Sum (256-(Sum of bytes 12H to 67h) (PER UNIT)	157	9D

COMMUNICATION BUS DESCRIPTIONS

LCC600-12H-9P FRU (EEPROM) Data:

OFFSET		DEFINITION (REMARKS)	SPEC VALUE	
(DEC)	(HEX)		(DEC)	(HEX)
MULTI RECORD AREA				
104	68	Power Supply Record Header (72 Bytes) Record Type ID (0x00 = Power Supply Information)	0	00
105	69	3-0: (0010)b, Record Format Version	2	02
106	6A	Record Length: 24 Bytes	24	18
107	6B	Record Checksum (Zero Checksum From 109d To 132d)	197	C5
108	6C	Header Checksum (Zero Checksum From 104d To 107d)	33	21
POWER SUPPLY RECORD				
109	6D	Overall Capacity of the Power Supply,	88	58
110	6E	15-12: (0000)b, Reserved 11-0: (000111001000)b, 600W = 0258H	2	02
111	6F	15-12: (0000)b, Reserved	138	8A
112	70	11-0: (001000011100)b, 650W = 028AH	2	02
113	71	Inrush Current (Amps)	25	19
114	72	Inrush Interval, 200mS	200	C8
115	73	Low End Input Voltage Range 1(10mV) (180V / 10mV) 18000 = 4650H, 2 Bytes Sequence	80	50
116	74		70	46
117	75	High End Input Voltage Range 1(10mV), (305V/10mV) 30500= 7724H, 2 Bytes Sequence	36	24
118	76		119	77
119	77	Low End Input Voltage Range 2(10mV) Not Applicable (Auto switch)	0	00
120	78		0	00
121	79	High End Input Voltage Range 2(10mV) Not Applicable (Auto switch)	0	00
122	7A		0	00
123	7B	Low End Input Frequency Range, 47Hz = 2FH	47	2F
124	7C	Low End Input Frequency Range, 63Hz = 3FH	63	3F
125	7D	AC Dropout Tolerance in ms, 20mS= 14H	20	14
126	7E	Binary Flags, 15-11: (10100)b, Hold up Time in Seconds = 14H 10-0: (01001011000)b, Peak Capacity in Watts =258H	38	26
127	7F		88	58
128	80		162	A2
129	81		0	00
130	82	Byte 1 : Bits7-4 ; Voltage 1 Bits3-0 : Voltage2 Byte 2 and Byte 3: Total Combined Wattage	0	00
131	83	Stored with LSB first then MSB. Not Applicable	0	00
132	84	Predictive Fail Tachometer Lower Threshold, Not applicable	0	00
12V DC OUTPUT RECORD HEADER				
133	85	Record Type ID (0x01 = DC Output)	1	01
134	86	End Of List/Record Format Version Number	2	02
135	87	Record Length: 13 Bytes	13	0D

COMMUNICATION BUS DESCRIPTIONS

LCC600-12H-9P FRU (EEPROM) Data:

OFFSET		DEFINITION (REMARKS)	SPEC VALUE	
(DEC)	(HEX)		(DEC)	(HEX)
136	88	Record Checksum (Zero Checksum From 138d To 150d)	163	A3
137	89	Header Checksum (Zero Checksum From 133d To 136d)	77	4D
12V OUTPUT RECORD				
138	8A	Output Information , 001 = 01H, +12V Output Information	1	01
139	8B	Nominal Voltage 12.00V = 1200 (x10mV) = 04B0H	176	B0
140	8C		4	04
141	8D	Maximum Negative Voltage Deviation 12.00V = 1200 (x10mV) = 04B0H, 2 Bytes Sequence	176	B0
142	8E		4	04
143	8F	Maximum Positive Voltage Deviation 15V = 1500 (x10mV) = 05DCH, 2 Bytes Sequence	220	DC
144	90		5	05
145	91	Ripple and Noise pk-pk (mV) 120mV (x 1mV)= 0078H, 2 Bytes Sequence	120	78
146	92		0	00
147	93	Minimum Current Draw (10mA) , 0000 = 0000H, 2 Bytes Sequence	0	00
148	94		0	00
149	95	Minimum Current Draw (10mA) , 0000 = 0000H 50.0A = 5000 (x10mA) = 1388H	136	88
150	96		19	13
5VSB OUTPUT RECORD HEADER				
151	97	Record type ID (0x01 = DC Output)	1	01
152	98	End of List /Record Format Version Number for 5VSB Output Record	2	02
153	99	Record Length: 13 Bytes	13	0D
154	9A	Record CHECKSUM of 5VSB Output Record (Zero CHECKSUM)	214	D6
155	9B	(256-(sum of bytes 156 to 168)) Header CHECKSUM of 5VSB Output Record Header (Zero CHECKSUM) (256-(sum of bytes 151 to 154))	26	1A
156	9C	Output Information , 002 = 02H Bit 7: Standby Information = 1B Bits 6-4: Reserved, Write as 000B Bits 3-0: Output Number 2 = 010B	130	82
157	9D	Nominal Voltage 5.00V = 2500(x10mA) = 01F4H, 2 Bytes Sequence	244	F4
158	9E		1	01
159	9F	Maximum Negative Voltage Deviation 4.75V = 525 (x10mV) = 01DBH, 2 Bytes Sequence	219	DB
160	A0		1	01
161	A1	Maximum Positive Voltage Deviation 5.25V = 525(x10mA) = 020DH, 2 Bytes Sequence	13	0D
162	A2		2	02
163	A3	Ripple And Noise pk-pk (mV) 50mV = 0032H, 2 Bytes Sequence	50	32
164	A4		0	00
165	A5	Minimum Current Draw (10mA) 0000 = 000AH, 2 Bytes Sequence	0	00
166	A6		0	00
167	A7	Maximum Current Draw (10mA) , (6.0A / 10mA) 600 = 0258H 0150 = 0096H, 2 Bytes Sequence	150	96
168	A8		0	00

COMMUNICATION BUS DESCRIPTIONS

LCC600-12H-9P FRU (EEPROM) Data:

OFFSET		DEFINITION (REMARKS)	SPEC VALUE	
(DEC)	(HEX)		(DEC)	(HEX)
OEM RECORD HEADER				
169	A9	Record type = C0H for OEM Record	192	C0
170	AA	End of List /Record Format Version Number for 5V _{SB} output Record	130	82
171	AB	Record Length of OEM Record	42	2A
172	AC	Record CHECKSUM of OEM Record (Zero CHECKSUM)	0	00
173	AD	Header CHECKSUM of OEM Record Header (Zero CHECKSUM) (256-(sum of bytes 169 to 172))	148	94
OEM RECORD				
174	AE	Manufacturer ID (3 bytes, Default is 0)	0	00
175	AF	RESERVED	0	00
176	B0	RESERVED	0	00
177	B1	RESERVED	0	00
178	B2	RESERVED	0	00
179	B3	RESERVED	0	00
180	B4	RESERVED	0	00
181	B5	RESERVED	0	00
182	B6	RESERVED	0	00
183	B7	RESERVED	0	00
184	B8	RESERVED	0	00
185	B9	RESERVED	0	00
186	BA	RESERVED	0	00
187	BB	RESERVED	0	00
188	BC	RESERVED	0	00
189	BD	RESERVED	0	00
190	BE	RESERVED	0	00
191	BF	RESERVED	0	00
192	C0	RESERVED	0	00
193	C1	RESERVED	0	00
194	C2	RESERVED	0	00
195	C3	RESERVED	0	00
196	C4	RESERVED	0	00
197	C5	RESERVED	0	00
198	C6	RESERVED	0	00
199	C7	RESERVED	0	00
200	C8	RESERVED	0	00
201	C9	RESERVED	0	00
202	CA	RESERVED	0	00
203	CB	RESERVED	0	00
204	CC	RESERVED	0	00
205	CD	RESERVED	0	00
206	CE	RESERVED	0	00
207	CF	RESERVED	0	00
208	D0	RESERVED	0	00
209	D1	RESERVED	0	00
210	D2	RESERVED	0	00
211	D3	RESERVED	0	00
212	D4	RESERVED	0	00
213	D5	RESERVED	0	00
214	D6	RESERVED	0	00
215	D7	RESERVED	0	00

COMMUNICATION BUS DESCRIPTIONS

LCC600-28U-9P FRU (EEPROM) Data:

OFFSET		DEFINITION (REMARKS)	SPEC VALUE	
(DEC)	(HEX)		(DEC)	(HEX)
COMMON HEADER, 8 BYTES				
0	00	FORMAT VERSION NUMBER (Common Header) 7:4 - Reserved, write as 0000b 3:0 - Format Version Number = 1h for this specification	1	01
1	01	INTERNAL USE AREA OFFSET	27	1B
2	02	CHASSIS INFO AREA OFFSET	1	01
3	03	BOARD INFO AREA OFFSET	0	00
4	04	PRODUCT INFO AREA OFFSET	5	05
5	05	MULTI RECORD AREA OFFSET	13	0D
6	06	PAD (reserved) Default value is 0.	0	00
7	07	ZERO CHECK SUM (256 - (Sum of bytes 0 to 6))	209	D1
CHASSIS INFO AREA(32 BYTES)				
8	08	FORMAT VERSION NUMBER 7:4 - Reserved, write as 0000b 3:0 - Format Version Number = 1h for this specification	1	01
9	09	CHASSIS INFO AREA LENGTH in multiple of 8 bytes	4	04
10	0A	CHASSIS TYPE (Default value is 0.)	0	00
11	0B	CHASSIS PART NUMBER Type/Length CAh (if used) Type = "ASCII+LATIN1" = (11)b Length = 10 Bytes = (001010)b	193	C1
12	0C	Reserved	0	00
13	0D	Reserved	0	00
14	0E	Reserved	0	00
15	0F	Reserved	0	00
16	10	Reserved	0	00
17	11	Reserved	0	00
18	12	Reserved	0	00
19	13	Reserved	0	00
20	14	Reserved	0	00
21	15	Reserved	0	00
22	16	Reserved	0	00
23	17	Reserved	0	00
24	18	Reserved	0	00
25	19	Reserved	0	00
26	1A	Reserved	0	00
27	1B	Reserved	0	00
28	1C	Reserved	0	00
29	1D	Reserved	0	00
30	1E	Reserved	0	00

COMMUNICATION BUS DESCRIPTIONS

LCC600-28U-9P FRU (EEPROM) Data:

OFFSET		DEFINITION (REMARKS)	SPEC VALUE	
(DEC)	(HEX)		(DEC)	(HEX)
31	1F	Reserved	0	00
32	20	Reserved	0	00
33	21	Reserved	0	00
34	22	Reserved	0	00
35	23	Reserved	0	00
36	24	Reserved	0	00
37	25	Reserved	0	00
38	26	END TAG	0	00
39	27	ZERO CHECK SUM (256 – (Sum of bytes offset 8h to 26h))	58	3A
PRODUCT INFORMATION AREA				
40	28	FORMAT VERSION NUMBER (Product Info Area) 7:4 – Reserved, write as 0000b 3:0 – Format Version Number =1h for this specification	1	01
41	29	PRODUCT INFO AREA LENGTH (In multiples of 8 bytes)	8	08
42	2A	Language (English)	25	19
43	2B	MANUFACTURER NAME TYPE / LENGTH 7:6 – (11)b, 8-Bit ASCII + Latin 1, 5:0 – (000111)b, 7-Byte Allocation	199	C7
		MANUFACTURER'S NAME 7 byte sequence "ARTESYN"		
44	2C	"A" = 41h	65	41
45	2D	"R" = 52h	82	52
46	2E	"T" = 54h	84	54
47	2F	"E" = 45h	69	45
48	30	"S" = 53h	83	53
49	31	"Y" = 59h	89	59
50	32	"N" = 4Eh	78	4E
51	33	PRODUCT NAME Type/Length (CDh) Type = "ASCII+LATIN1" = (11)b; Length = 13 Bytes = (001101)b	206	CE
		PRODUCT NAME BYTES (14 Byte sequence) "LCC600-28U-9P"		
52	34	"L" = 4Ch	76	4C
53	35	"C" = 43h	67	43
54	36	"C" = 43h	67	43
55	37	"6" = 36h	54	36
56	38	"O" = 30h	48	30
57	39	"O" = 30h	48	30
58	3A	"-" = 2Dh	45	2D
59	3B	"2" = 32h	50	32
60	3C	"8" = 38h	56	38
61	3D	"U" = 55h	85	55
62	3E	"-" = 2Dh	45	2D
63	3F	"9" = 39h	57	39
64	40	"P" = 50h	80	50
65	41	Space = 20h	32	20

COMMUNICATION BUS DESCRIPTIONS

LCC600-28U-9P FRU (EEPROM) Data:

OFFSET		DEFINITION (REMARKS)	SPEC VALUE	
(DEC)	(HEX)		(DEC)	(HEX)
66	42	PRODUCT PART/MODEL NUMBER Type/Length (Cah) Type = "ASCII+LATIN1" = (11)b Length = 10 Bytes = (001010)b	202	CA
67	43	Reserved	0	00
68	44	Reserved	0	00
69	45	Reserved	0	00
70	46	Reserved	0	00
71	47	Reserved	0	00
72	48	Reserved	0	00
73	49	Reserved	0	00
74	4A	Reserved	0	00
75	4B	Reserved	0	00
76	4C	Reserved	0	00
77	4D	PRODUCT VERSION NUMBER Type/Length (C2h) Type = "ASCII+LATIN1" = (11)b Length = 2 bytes = (000010)b	194	C2
		PRODUCT VERSION NUMBER BYTES Refer to BOM TLA for latest revision		
78	4E	"A"	65	41
79	4F	"A"	65	41
80	50	PRODUCT SERIAL NUMBER Type/Length Type = "ASCII+LATIN1" = (11)b Length = 13 bytes = (001101)b	205	CD
		PRODUCT SERIAL NUMBER BYTES Model ID = "K618"		
81	51	"K" = 4Bh	75	4B
82	52	"O" = 36h	54	36
83	53	"1" = 31h	49	31
84	54	"8" = 38h	56	38
		MANUFACTURING YEAR AND WEEK CODE (PER UNIT)		
85	55	"W"	87	57
86	56	"W"	87	57
87	57	UNIQUE SERIAL NUMBER (PER UNIT) "SSSS"	83	53
88	58	In Decimal = 083, 083, 083, 083	83	53
89	59	In Hex = 53H, 53H, 53H, 53H	83	53
90	5A	In Hex = 53H, 53H, 53H, 53H	83	53
		MODEL REVISION (PER UNIT) Artesyn Model Rev, See Latest Model Rev in BOM TLA for latest revision		
91	5B	"A"	65	41
92	5C	"A"	65	41
93	5D	"P" = 5AH, (For Zhongshan, China) MANUFACTURING LOCATION (PER UNIT)	90	5A
94	5E	End Tag In Decimal: 193 In Hex: 0C1H	193	C1
95	5F	Reserved	0	00
96	60	Reserved	0	00
97	61	Reserved	0	00
98	62	Reserved	0	00
99	63	Reserved	0	00
100	64	Reserved	0	00
101	65	Reserved	0	00
102	66	Reserved	0	00
103	67	Zero Check Sum (256-(Sum of bytes 28h to 67h) (PER UNIT)		

COMMUNICATION BUS DESCRIPTIONS

LCC600-28U-9P FRU (EEPROM) Data:

OFFSET		DEFINITION (REMARKS)	SPEC VALUE	
(DEC)	(HEX)		(DEC)	(HEX)
MULTI RECORD AREA				
104	68	Power Supply Record Header (72 Bytes) Record Type ID (0x00 = Power Supply Information)	0	00
105	69	3-0: (0010)b, Record Format Version	2	02
106	6A	Record Length: 24 Bytes	24	18
107	6B	Record Checksum (Zero Checksum From 109d To 132d)	197	C5
108	6C	Header Checksum (Zero Checksum From 104d To 107d)	33	21
POWER SUPPLY RECORD				
109	6D	Overall Capacity of the Power Supply, 15-12: (0000)b, Reserved	88	58
110	6E	11-0: (000111001000)b, 600W = 0258H	2	02
111	6F	15-12: (0000)b, Reserved	138	8A
112	70	11-0: (001000011100)b, 650W = 028AH	2	02
113	71	Inrush Current (Amps)	25	19
114	72	Inrush Interval, 200mS	200	C8
115	73	Low End Input Voltage Range 1(10mV)	40	28
116	74	(90V / 10mV) 9000 = 2328H, 2 Bytes Sequence	35	23
117	75	High End Input Voltage Range 1(10mV)	32	20
118	76	(264V/10mV) 26400= 6720H, 2 Bytes Sequence	103	67
119	77	Low End Input Voltage Range 2(10mV)	0	00
120	78	Not Applicable (Autoswitch)	0	00
121	79	High End Input Voltage Range 2(10mV)	0	00
122	7A	Not Applicable (Autoswitch)	0	00
123	7B	Low End Input Frequency Range, 47Hz = 2FH	47	2F
124	7C	Low End Input Frequency Range, 63Hz = 3FH	63	3F
125	7D	AC Dropout Tolerance in ms, 20mS= 14H	20	14
126	7E	Binary Flags,	38	26
127	7F	15-11: (10100)b, Hold up Time in Seconds = 14H	88	58
128	80	10-0: (01001011000)b, Peak Capacity in Watts =258H	162	A2
129	81	Byte 1 : Bits7-4 ; Voltage 1 Bits3-0 : Voltage2	0	00
130	82	Byte 2 and Byte 3: Total Combined Wattage	0	00
131	83	Stored with LSB first then MSB. Not Applicable	0	00
132	84	Predictive Fail Tachometer Lower Threshold, Not applicable	0	00
28V DC OUTPUT RECORD HEADER				
133	85	Record Type ID (0x01 = DC Output)	1	01
134	86	End Of List/Record Format Version Number	2	02
135	87	Record Length: 13 Bytes	13	0D

COMMUNICATION BUS DESCRIPTIONS

LCC600-28U-9P FRU (EEPROM) Data:

OFFSET		DEFINITION (REMARKS)	SPEC VALUE	
(DEC)	(HEX)		(DEC)	(HEX)
136	88	Record Checksum (Zero Checksum From 138d To 150d)	243	F3
137	89	Header Checksum (Zero Checksum From 133d To 136d)	253	FD
28V OUTPUT RECORD				
138	8A	Output Information , 001 = 01H, +28V Output Information	1	01
139	8B	Nominal Voltage 28.00V = 2800 (x10mV) = 0AF0H	240	F0
140	8C		10	0A
141	8D	Maximum Negative Voltage Deviation 24.00V = 2400 (x10mV) = 0960H, 2 Bytes Sequence	96	60
142	8E		9	09
143	8F	Maximum Positive Voltage Deviation 30.00V = 3000 (x10mV) = 1518H, 2 Bytes Sequence	184	B8
144	90		11	0B
145	91	Ripple and Noise pk-pk (mV) 280mV (x 1mV)= 0118H, 2 Bytes Sequence	24	18
146	92		1	01
147	93	Minimum Current Draw (10mA), 0000 = 0000H, 2 Bytes Sequence	0	00
148	94		0	00
149	95	Minimum Current Draw (10mA), 0000 = 0000H 25A = 2500(x10mA) = 09C4H	196	C4
150	96		9	09
5VSB OUTPUT RECORD HEADER				
151	97	Record type ID (0x01 = DC Output)	1	01
152	98	End of List /Record Format Version Number for 5VSB Output Record	2	02
153	99	Record Length: 13 Bytes	13	0D
154	9A	Record CHECKSUM of 5VSB Output Record (Zero CHECKSUM)	214	D6
155	9B	(256-(sum of bytes 156 to 168)) Header CHECKSUM of 5VSB Output Record Header (Zero CHECKSUM) (256-(sum of bytes 151 to 154))	26	1A
156	9C	Output Information , 002 = 02H Bit 7: Standby Information = 1B Bits 6-4: Reserved, Write as 000B Bits 3-0: Output Number 2 = 010B	130	82
157	9D	Nominal Voltage 5.00V = 2500(x10mA) = 01F4H, 2 Bytes Sequence	244	F4
158	9E		1	01
159	9F	Maximum Negative Voltage Deviation 4.75V = 525 (x10mV) = 01DBH, 2 Bytes Sequence	219	DB
160	A0		1	01
161	A1	Maximum Positive Voltage Deviation 5.25V = 525(x10mA) = 020DH, 2 Bytes Sequence	13	0D
162	A2		2	02
163	A3	Ripple And Noise pk-pk (mV) 50mV = 0032H, 2 Bytes Sequence	50	32
164	A4		0	00
165	A5	Minimum Current Draw (10mA) 0000 = 000AH, 2 Bytes Sequence	0	00
166	A6		0	00
167	A7	Maximum Current Draw (10mA), (6.0A / 10mA) 600 = 0258H 0150 = 0096H, 2 Bytes Sequence	150	96
168	A8		0	00

COMMUNICATION BUS DESCRIPTIONS

LCC600-28U-9P FRU (EEPROM) Data:

OFFSET		DEFINITION (REMARKS)	SPEC VALUE	
(DEC)	(HEX)		(DEC)	(HEX)
OEM RECORD HEADER				
169	A9	Record type = C0H for OEM Record	192	C0
170	AA	End of List /Record Format Version Number for 5V V _{SB} output Record	130	82
171	AB	Record Length of OEM Record	42	2A
172	AC	Record CHECKSUM of OEM Record (Zero CHECKSUM)	0	00
173	AD	Header CHECKSUM of OEM Record Header (Zero CHECKSUM) (256-(sum of bytes 169 to 172))	148	94
OEM RECORD				
174	AE	Manufacturer ID (3 bytes, Default is 0)	0	00
175	AF	RESERVED	0	00
176	B0	RESERVED	0	00
177	B1	RESERVED	0	00
178	B2	RESERVED	0	00
179	B3	RESERVED	0	00
180	B4	RESERVED	0	00
181	B5	RESERVED	0	00
182	B6	RESERVED	0	00
183	B7	RESERVED	0	00
184	B8	RESERVED	0	00
185	B9	RESERVED	0	00
186	BA	RESERVED	0	00
187	BB	RESERVED	0	00
188	BC	RESERVED	0	00
189	BD	RESERVED	0	00
190	BE	RESERVED	0	00
191	BF	RESERVED	0	00
192	C0	RESERVED	0	00
193	C1	RESERVED	0	00
194	C2	RESERVED	0	00
195	C3	RESERVED	0	00
196	C4	RESERVED	0	00
197	C5	RESERVED	0	00
198	C6	RESERVED	0	00
199	C7	RESERVED	0	00
200	C8	RESERVED	0	00
201	C9	RESERVED	0	00
202	CA	RESERVED	0	00
203	CB	RESERVED	0	00
204	CC	RESERVED	0	00
205	CD	RESERVED	0	00
206	CE	RESERVED	0	00
207	CF	RESERVED	0	00
208	D0	RESERVED	0	00
209	D1	RESERVED	0	00
210	D2	RESERVED	0	00
211	D3	RESERVED	0	00
212	D4	RESERVED	0	00
213	D5	RESERVED	0	00
214	D6	RESERVED	0	00
215	D7	RESERVED	0	00

COMMUNICATION BUS DESCRIPTIONS

LCC600-28H-9P FRU (EEPROM) Data:

OFFSET		DEFINITION (REMARKS)	SPEC VALUE	
(DEC)	(HEX)		(DEC)	(HEX)
COMMON HEADER, 8 BYTES				
0	00	FORMAT VERSION NUMBER (Common Header) 7:4 - Reserved, write as 0000b 3:0 - Format Version Number = 1h for this specification	1	01
1	01	INTERNAL USE AREA OFFSET	27	1B
2	02	CHASSIS INFO AREA OFFSET	1	01
3	03	BOARD INFO AREA OFFSET	0	00
4	04	PRODUCT INFO AREA OFFSET	5	05
5	05	MULTI RECORD AREA OFFSET	13	0D
6	06	PAD (reserved) Default value is 0.	0	00
7	07	ZERO CHECK SUM (256 - (Sum of bytes 0 to 6))	209	D1
CHASSIS INFO AREA(32 BYTES)				
8	08	FORMAT VERSION NUMBER 7:4 - Reserved, write as 0000b 3:0 - Format Version Number = 1h for this specification	1	01
9	09	CHASSIS INFO AREA LENGTH in multiple of 8 bytes	4	04
10	0A	CHASSIS TYPE (Default value is 0.)	0	00
11	0B	CHASSIS PART NUMBER Type/Length CAh (if used) Type = "ASCII+LATIN1" = (11)b Length = 10 Bytes = (001010)b	193	C1
12	0C	Reserved	0	00
13	0D	Reserved	0	00
14	0E	Reserved	0	00
15	0F	Reserved	0	00
16	10	Reserved	0	00
17	11	Reserved	0	00
18	12	Reserved	0	00
19	13	Reserved	0	00
20	14	Reserved	0	00
21	15	Reserved	0	00
22	16	Reserved	0	00
23	17	Reserved	0	00
24	18	Reserved	0	00
25	19	Reserved	0	00
26	1A	Reserved	0	00
27	1B	Reserved	0	00
28	1C	Reserved	0	00
29	1D	Reserved	0	00
30	1E	Reserved	0	00

COMMUNICATION BUS DESCRIPTIONS

LCC600-28H-9P FRU (EEPROM) Data:

OFFSET		DEFINITION (REMARKS)	SPEC VALUE	
(DEC)	(HEX)		(DEC)	(HEX)
31	1F	Reserved	0	00
32	20	Reserved	0	00
33	21	Reserved	0	00
34	22	Reserved	0	00
35	23	Reserved	0	00
36	24	Reserved	0	00
37	25	Reserved	0	00
38	26	END TAG	0	00
39	27	ZERO CHECK SUM (256 – (Sum of bytes offset 8h to 26h))	58	3A
PRODUCT INFORMATION AREA				
40	28	FORMAT VERSION NUMBER (Product Info Area) 7:4 – Reserved, write as 0000b 3:0 – Format Version Number =1h for this specification	1	01
41	29	PRODUCT INFO AREA LENGTH (In multiples of 8 bytes)	8	08
42	2A	Language (English)	25	19
43	2B	MANUFACTURER NAME TYPE / LENGTH 7:6 – (11)b, 8-Bit ASCII + Latin 1, 5:0 – (000111)b, 7-Byte Allocation	199	C7
		MANUFACTURER'S NAME 7 byte sequence "ARTESYN"		
44	2C	"A" = 41h	65	41
45	2D	"R" = 52h	82	52
46	2E	"T" = 54h	84	54
47	2F	"E" = 45h	69	45
48	30	"S" = 53h	83	53
49	31	"Y" = 59h	89	59
50	32	"N" = 4Eh	78	4E
51	33	PRODUCT NAME Type/Length (CDh) Type = "ASCII+LATIN1" = (11)b; Length = 13 Bytes = (001101)b	206	CE
		PRODUCT NAME BYTES (14 Byte sequence) "LCC600-28H-9P"		
52	34	"L" = 4Ch	76	4C
53	35	"C" = 43h	67	43
54	36	"C" = 43h	67	43
55	37	"6" = 36h	54	36
56	38	"O" = 30h	48	30
57	39	"O" = 30h	48	30
58	3A	"-" = 2Dh	45	2D
59	3B	"2" = 32h	50	32
60	3C	"8" = 38h	56	38
61	3D	"H" = 48h	72	48
62	3E	"-" = 2Dh	45	2D
63	3F	"9" = 39h	57	39
64	40	"P" = 50h	80	50
65	41	Space = 20h	32	20

COMMUNICATION BUS DESCRIPTIONS

LCC600-28H-9P FRU (EEPROM) Data:

OFFSET		DEFINITION	SPEC VALUE	
(DEC)	(HEX)	(REMARKS)	(DEC)	(HEX)
66	42	PRODUCT PART/MODEL NUMBER Type/Length (Cah) Type = "ASCII+LATIN1" = (11)b Length = 10 Bytes = (001010)b	202	CA
67	43	Reserved	0	00
68	44	Reserved	0	00
69	45	Reserved	0	00
70	46	Reserved	0	00
71	47	Reserved	0	00
72	48	Reserved	0	00
73	49	Reserved	0	00
74	4A	Reserved	0	00
75	4B	Reserved	0	00
76	4C	Reserved	0	00
77	4D	PRODUCT VERSION NUMBER Type/Length (C2h) Type = "ASCII+LATIN1" = (11)b Length = 2 bytes = (000010)b	194	C2
		PRODUCT VERSION NUMBER BYTES Refer to BOM TLA for latest revision		
78	4E	"A"	65	41
79	4F	"A"	65	41
80	50	PRODUCT SERIAL NUMBER Type/Length Type = "ASCII+LATIN1" = (11)b Length = 13 bytes = (001101)b	205	CD
		PRODUCT SERIAL NUMBER BYTES Model ID = "K620"		
81	51	"K" = 4Bh	75	4B
82	52	"6" = 36h	56	36
83	53	"2" = 32h	57	32
84	54	"0" = 30h	53	30
		MANUFACTURING YEAR AND WEEK CODE (PER UNIT)		
85	55	"W"	87	57
86	56	"W"	87	57
87	57	UNIQUE SERIAL NUMBER (PER UNIT) "SSSS"	83	53
88	58	In Decimal = 083, 083, 083, 083	83	53
89	59	In Hex = 53H, 53H, 53H, 53H	83	53
90	5A	In Hex = 53H, 53H, 53H, 53H	83	53
		MODEL REVISION (PER UNIT) Artesyn Model Rev, See Latest Model Rev in BOM TLA for latest revision		
91	5B	"A"	65	41
92	5C	"A"	65	41
93	5D	"P" = 5AH, (For Zhongshan, China) MANUFACTURING LOCATION (PER UNIT)	90	5A
94	5E	End Tag In Decimal: 193 In Hex: 0C1H	193	C1
95	5F	Reserved	0	00
96	60	Reserved	0	00
97	61	Reserved	0	00
98	62	Reserved	0	00
99	63	Reserved	0	00
100	64	Reserved	0	00
101	65	Reserved	0	00
102	66	Reserved	0	00
103	67	Zero Check Sum (256-(Sum of bytes 28h to 67h) (PER UNIT)	157	9D

COMMUNICATION BUS DESCRIPTIONS

LCC600-28H-9P FRU (EEPROM) Data:

OFFSET		DEFINITION (REMARKS)	SPEC VALUE	
(DEC)	(HEX)		(DEC)	(HEX)
MULTI RECORD AREA				
104	68	Power Supply Record Header (72 Bytes) Record Type ID (0x00 = Power Supply Information)	0	00
105	69	3-0: (0010)b, Record Format Version	2	02
106	6A	Record Length: 24 Bytes	24	18
107	6B	Record Checksum (Zero Checksum From 109d To 132d)	197	C5
108	6C	Header Checksum (Zero Checksum From 104d To 107d)	33	21
POWER SUPPLY RECORD				
109	6D	Overall Capacity of the Power Supply,	88	58
110	6E	15-12: (0000)b, Reserved 11-0: (000111001000)b, 600W = 0258H	2	02
111	6F	15-12: (0000)b, Reserved	138	8A
112	70	11-0: (001000011100)b, 650W = 028AH	2	02
113	71	Inrush Current (Amps)	25	19
114	72	Inrush Interval, 200mS	200	C8
115	73	Low End Input Voltage Range 1(10mV) (180V / 10mV) 18000 = 4650H, 2 Bytes Sequence	80	50
116	74		70	46
117	75	High End Input Voltage Range 1(10mV), (305V/10mV) 30500= 7724H, 2 Bytes Sequence	36	24
118	76		119	77
119	77	Low End Input Voltage Range 2(10mV) Not Applicable (Autoswitch)	0	00
120	78		0	00
121	79	High End Input Voltage Range 2(10mV) Not Applicable (Autoswitch)	0	00
122	7A		0	00
123	7B	Low End Input Frequency Range, 47Hz = 2FH	47	2F
124	7C	Low End Input Frequency Range, 63Hz = 3FH	63	3F
125	7D	AC Dropout Tolerance in ms, 20mS= 14H	20	14
126	7E	Binary Flags, 15-11: (10100)b, Hold up Time in Seconds = 14H 10-0: (01001011000)b, Peak Capacity in Watts =258H	38	26
127	7F		88	58
128	80		162	A2
129	81	Byte 1 : Bits7-4 ; Voltage 1 Bits3-0 : Voltage2	0	00
130	82	Byte 2 and Byte 3: Total Combined Wattage	0	00
131	83	Stored with LSB first then MSB. Not Applicable	0	00
132	84	Predictive Fail Tachometer Lower Threshold, Not applicable	0	00
28V DC OUTPUT RECORD HEADER				
133	85	Record Type ID (0x01 = DC Output)	1	01
134	86	End Of List/Record Format Version Number	2	02
135	87	Record Length: 13 Bytes	13	0D

COMMUNICATION BUS DESCRIPTIONS

LCC600-28H-9P FRU (EEPROM) Data:

OFFSET		DEFINITION (REMARKS)	SPEC VALUE	
(DEC)	(HEX)		(DEC)	(HEX)
136	88	Record Checksum (Zero Checksum From 138d To 150d)	243	F3
137	89	Header Checksum (Zero Checksum From 133d To 136d)	253	FD
28V OUTPUT RECORD				
138	8A	Output Information , 001 = 01H, +28V Output Information	1	01
139	8B	Nominal Voltage 28.00V = 2800 (x10mV) = 0AF0H	240	F0
140	8C		10	0A
141	8D	Maximum Negative Voltage Deviation 24.00V = 2400 (x10mV) = 0960H, 2 Bytes Sequence	96	60
142	8E		9	09
143	8F	Maximum Positive Voltage Deviation 30.00V = 3000 (x10mV) = 0BB8H, 2 Bytes Sequence	184	B8
144	90		11	0B
145	91	Ripple and Noise pk-pk (mV) 280mV (x 1mV)= 0118H, 2 Bytes Sequence	24	18
146	92		1	01
147	93	Minimum Current Draw (10mA) 0000 = 0000H, 2 Bytes Sequence	0	00
148	94		0	00
149	95	Minimum Current Draw (10mA) , 0000 = 0000H 25A = 2500(x10mA) = 09C4H	196	C4
150	96		9	09
5VSB OUTPUT RECORD HEADER				
151	97	Record type ID (0x01 = DC Output)	1	01
152	98	End of List /Record Format Version Number for 5VSB Output Record	2	02
153	99	Record Length: 13 Bytes	13	0D
154	9A	Record CHECKSUM of 5VSB Output Record (Zero CHECKSUM)	214	D6
155	9B	(256-(sum of bytes 156 to 168)) Header CHECKSUM of 5VSB Output Record Header (Zero CHECKSUM) (256-(sum of bytes 151 to 154))	26	1A
156	9C	Output Information , 002 = 02H Bit 7: Standby Information = 1B Bits 6-4: Reserved, Write as 000B Bits 3-0: Output Number 2 = 010B	130	82
157	9D	Nominal Voltage 5.00V = 2500(x10mA) = 01F4H, 2 Bytes Sequence	244	F4
158	9E		1	01
159	9F	Maximum Negative Voltage Deviation 4.75V = 525 (x10mV) = 01DBH, 2 Bytes Sequence	219	DB
160	A0		1	01
161	A1	Maximum Positive Voltage Deviation 5.25V = 525(x10mA) = 020DH, 2 Bytes Sequence	13	0D
162	A2		2	02
163	A3	Ripple And Noise pk-pk (mV) 50mV = 0032H, 2 Bytes Sequence	50	32
164	A4		0	00
165	A5	Minimum Current Draw (10mA) 0000 = 000AH, 2 Bytes Sequence	0	00
166	A6		0	00
167	A7	Maximum Current Draw (10mA) , (6.0A / 10mA) 600 = 0258H 0150 = 0096H, 2 Bytes Sequence	150	96
168	A8		0	00

COMMUNICATION BUS DESCRIPTIONS

LCC600-28H-9P FRU (EEPROM) Data:

OFFSET		DEFINITION	SPEC VALUE	
(DEC)	(HEX)	(REMARKS)	(DEC)	(HEX)
OEM RECORD HEADER				
169	A9	Record type = C0H for OEM Record	192	C0
170	AA	End of List /Record Format Version Number for 5V V _{SB} output Record	130	82
171	AB	Record Length of OEM Record	42	2A
172	AC	Record CHECKSUM of OEM Record (Zero CHECKSUM)	0	00
173	AD	Header CHECKSUM of OEM Record Header (Zero CHECKSUM) (256-(sum of bytes 169 to 172))	148	94
OEM RECORD				
174	AE	Manufacturer ID (3 bytes, Default is 0)	0	00
175	AF	RESERVED	0	00
176	B0	RESERVED	0	00
177	B1	RESERVED	0	00
178	B2	RESERVED	0	00
179	B3	RESERVED	0	00
180	B4	RESERVED	0	00
181	B5	RESERVED	0	00
182	B6	RESERVED	0	00
183	B7	RESERVED	0	00
184	B8	RESERVED	0	00
185	B9	RESERVED	0	00
186	BA	RESERVED	0	00
187	BB	RESERVED	0	00
188	BC	RESERVED	0	00
189	BD	RESERVED	0	00
190	BE	RESERVED	0	00
191	BF	RESERVED	0	00
192	C0	RESERVED	0	00
193	C1	RESERVED	0	00
194	C2	RESERVED	0	00
195	C3	RESERVED	0	00
196	C4	RESERVED	0	00
197	C5	RESERVED	0	00
198	C6	RESERVED	0	00
199	C7	RESERVED	0	00
200	C8	RESERVED	0	00
201	C9	RESERVED	0	00
202	CA	RESERVED	0	00
203	CB	RESERVED	0	00
204	CC	RESERVED	0	00
205	CD	RESERVED	0	00
206	CE	RESERVED	0	00
207	CF	RESERVED	0	00
208	D0	RESERVED	0	00
209	D1	RESERVED	0	00
210	D2	RESERVED	0	00
211	D3	RESERVED	0	00
212	D4	RESERVED	0	00
213	D5	RESERVED	0	00
214	D6	RESERVED	0	00
215	D7	RESERVED	0	00

COMMUNICATION BUS DESCRIPTIONS

LCC600-36U-9P FRU (EEPROM) Data:

OFFSET		DEFINITION	SPEC VALUE	
(DEC)	(HEX)	(REMARKS)	(DEC)	(HEX)
COMMON HEADER, 8 BYTES				
0	00	FORMAT VERSION NUMBER (Common Header) 7:4 - Reserved, write as 0000b 3:0 - Format Version Number = 1h for this specification	1	01
1	01	INTERNAL USE AREA OFFSET	27	1B
2	02	CHASSIS INFO AREA OFFSET	1	01
3	03	BOARD INFO AREA OFFSET	0	00
4	04	PRODUCT INFO AREA OFFSET	5	05
5	05	MULTI RECORD AREA OFFSET	13	0D
6	06	PAD (reserved) Default value is 0.	0	00
7	07	ZERO CHECK SUM (256 – (Sum of bytes 0 to 6))	209	D1
CHASSIS INFO AREA(32 BYTES)				
8	08	FORMAT VERSION NUMBER 7:4 - Reserved, write as 0000b 3:0 - Format Version Number = 1h for this specification	1	01
9	09	CHASSIS INFO AREA LENGTH in multiple of 8 bytes	4	04
10	0A	CHASSIS TYPE (Default value is 0.)	0	00
11	0B	CHASSIS PART NUMBER Type/Length CAh (if used) Type = "ASCII+LATIN1" = (11)b Length = 10 Bytes = (001010)b	193	C1
12	0C	Reserved	0	00
13	0D	Reserved	0	00
14	0E	Reserved	0	00
15	0F	Reserved	0	00
16	10	Reserved	0	00
17	11	Reserved	0	00
18	12	Reserved	0	00
19	13	Reserved	0	00
20	14	Reserved	0	00
21	15	Reserved	0	00
22	16	Reserved	0	00
23	17	Reserved	0	00
24	18	Reserved	0	00
25	19	Reserved	0	00
26	1A	Reserved	0	00
27	1B	Reserved	0	00
28	1C	Reserved	0	00
29	1D	Reserved	0	00
30	1E	Reserved	0	00

COMMUNICATION BUS DESCRIPTIONS

LCC600-36U-9P FRU (EEPROM) Data:

OFFSET		DEFINITION (REMARKS)	SPEC VALUE	
(DEC)	(HEX)		(DEC)	(HEX)
31	1F	Reserved	0	00
32	20	Reserved	0	00
33	21	Reserved	0	00
34	22	Reserved	0	00
35	23	Reserved	0	00
36	24	Reserved	0	00
37	25	Reserved	0	00
38	26	END TAG	0	00
39	27	ZERO CHECK SUM (256 – (Sum of bytes offset 8h to 26h))	58	3A
PRODUCT INFORMATION AREA				
40	28	FORMAT VERSION NUMBER (Product Info Area) 7:4 – Reserved, write as 0000b 3:0 – Format Version Number =1h for this specification	1	01
41	29	PRODUCT INFO AREA LENGTH (In multiples of 8 bytes)	8	08
42	2A	Language (English)	25	19
43	2B	MANUFACTURER NAME TYPE / LENGTH 7:6 - (11)b, 8-Bit ASCII + Latin 1, 5:0 - (000111)b, 7-Byte Allocation	199	C7
		MANUFACTURER'S NAME 7 byte sequence "ARTESYN"		
44	2C	"A" = 41h	65	41
45	2D	"R" = 52h	82	52
46	2E	"T" = 54h	84	54
47	2F	"E" = 45h	69	45
48	30	"S" = 53h	83	53
49	31	"Y" = 59h	89	59
50	32	"N" = 4Eh	78	4E
51	33	PRODUCT NAME Type/Length (CDh) Type = "ASCII+LATIN1" = (11)b; Length = 13 Bytes = (001101)b	206	CE
		PRODUCT NAME BYTES (14 Byte sequence) "LCC600-36U-9P"		
52	34	"L"=4Ch	76	4C
53	35	"C"=43h	67	43
54	36	"C"=43h	67	43
55	37	"6"=36h	54	36
56	38	"0"=30h	48	30
57	39	"0"=30h	48	30
58	3A	"-"=2Dh	45	2D
59	3B	"3"=33h	52	33
60	3C	"6"=36h	56	36
61	3D	"U"=55h	85	55
62	3E	"-"=2Dh	45	2D
63	3F	"9"=39h	57	39
64	40	"P"=50h	80	50
65	41	Space=20h	32	20

COMMUNICATION BUS DESCRIPTIONS

LCC600-36U-9P FRU (EEPROM) Data:

OFFSET		DEFINITION (REMARKS)	SPEC VALUE	
(DEC)	(HEX)		(DEC)	(HEX)
66	42	PRODUCT PART/MODEL NUMBER Type/Length (Cah) Type = "ASCII+LATIN1" = (11)b Length = 10 Bytes = (001010)b	202	CA
67	43	Reserved	0	00
68	44	Reserved	0	00
69	45	Reserved	0	00
70	46	Reserved	0	00
71	47	Reserved	0	00
72	48	Reserved	0	00
73	49	Reserved	0	00
74	4A	Reserved	0	00
75	4B	Reserved	0	00
76	4C	Reserved	0	00
77	4D	PRODUCT VERSION NUMBER Type/Length (C2h) Type = "ASCII+LATIN1" = (11)b Length = 2 bytes = (000010)b	194	C2
		PRODUCT VERSION NUMBER BYTES Refer to BOM TLA for latest revision		
78	4E	"A"	65	41
79	4F	"A"	65	41
80	50	PRODUCT SERIAL NUMBER Type/Length Type = "ASCII+LATIN1" = (11)b Length = 13 bytes = (001101)b	205	CD
		PRODUCT SERIAL NUMBER BYTES Model ID = "L292"		
81	51	"L" = 4Bh	75	4C
82	52	"2" = 38h	56	32
83	53	"9" = 39h	57	39
84	54	"2" = 35h	53	32
		MANUFACTURING YEAR AND WEEK CODE (PER UNIT)		
85	55	"W"	87	57
86	56	"W"	87	57
87	57	UNIQUE SERIAL NUMBER (PER UNIT) "SSSS"	83	53
88	58	In Decimal = 083, 083, 083, 083	83	53
89	59	In Hex = 53H, 53H, 53H, 53H	83	53
90	5A		83	53
		MODEL REVISION (PER UNIT) Artesyn Model Rev, See Latest Model Rev in BOM TLA for latest revision		
91	5B	"A"	65	41
92	5C	"A"	65	41
93	5D	"P" = 50H, (For Laguna, Philippines) MANUFACTURING LOCATION (PER UNIT)	80	50
94	5E	End Tag In Decimal: 193 In Hex: 0C1H	193	C1
95	5F	Reserved	0	00
96	60	Reserved	0	00
97	61	Reserved	0	00
98	62	Reserved	0	00
99	63	Reserved	0	00
100	64	Reserved	0	00
101	65	Reserved	0	00
102	66	Reserved	0	00
103	67	Zero Check Sum (256-(Sum of bytes 28h to 67h) (PER UNIT)		

COMMUNICATION BUS DESCRIPTIONS

LCC600-36U-9P FRU (EEPROM) Data:

OFFSET		DEFINITION (REMARKS)	SPEC VALUE	
(DEC)	(HEX)		(DEC)	(HEX)
MULTI RECORD AREA				
104	68	Power Supply Record Header (72 Bytes) Record Type ID (0x00 = Power Supply Information)	0	00
105	69	3-0: (0010)b, Record Format Version	2	02
106	6A	Record Length: 24 Bytes	24	18
107	6B	Record Checksum (Zero Checksum From 109d To 132d)	197	C5
108	6C	Header Checksum (Zero Checksum From 104d To 107d)	33	21
POWER SUPPLY RECORD				
109	6D	Overall Capacity of the Power Supply, 15-12: (0000)b, Reserved	88	58
110	6E	11-0: (000111001000)b, 600W = 0258H	2	02
111	6F	15-12: (0000)b, Reserved	138	8A
112	70	11-0: (001000011100)b, 650W = 028AH	2	02
113	71	Inrush Current (Amps)	25	19
114	72	Inrush Interval, 200mS	200	C8
115	73	Low End Input Voltage Range 1(10mV)	40	28
116	74	(90V / 10mV) 9000 = 2328H, 2 Bytes Sequence	35	23
117	75	High End Input Voltage Range 1(10mV)	32	20
118	76	(264V / 10mV) 26400= 6720H, 2 Bytes Sequence	103	67
119	77	Low End Input Voltage Range 2(10mV)	0	00
120	78	Not Applicable (Auto switch)	0	00
121	79	High End Input Voltage Range 2(10mV)	0	00
122	7A	Not Applicable (Auto switch)	0	00
123	7B	Low End Input Frequency Range, 47Hz = 2FH	47	2F
124	7C	Low End Input Frequency Range, 63Hz = 3FH	63	3F
125	7D	AC Dropout Tolerance in ms, 20mS= 14H	20	14
126	7E	Binary Flags,	38	26
127	7F	15-11: (10100)b, Hold up Time in Seconds = 14H	88	58
128	80	10-0: (01001011000)b, Peak Capacity in Watts =258H	162	A2
129	81	Byte 1 : Bits7-4 ; Voltage 1 Bits3-0 : Voltage2	0	00
130	82	Byte 2 and Byte 3: Total Combined Wattage	0	00
131	83	Stored with LSB first then MSB. Not Applicable	0	00
132	84	Predictive Fail Tachometer Lower Threshold, Not applicable	0	00
48V DC OUTPUT RECORD HEADER				
133	85	Record Type ID (0x01 = DC Output)	1	01
134	86	End Of List/Record Format Version Number	2	02
135	87	Record Length: 13 Bytes	13	0D

COMMUNICATION BUS DESCRIPTIONS

LCC600-36U-9P FRU (EEPROM) Data:

OFFSET		DEFINITION (REMARKS)	SPEC VALUE	
(DEC)	(HEX)		(DEC)	(HEX)
136	88	Record Checksum (Zero Checksum From 138d To 150d)	122	7A
137	89	Header Checksum (Zero Checksum From 133d To 136d)	118	76
36V OUTPUT RECORD				
138	8A	Output Information , 001 = 01H, +36V Output Information	1	01
139	8B	Nominal Voltage 36.00V = 3600 (x10mV) = 0E10H	16	10
140	8C		14	0E
141	8D	Maximum Negative Voltage Deviation 32.00V = 3200 (x10mV) = 0C80H, 2 Bytes Sequence	128	80
142	8E		12	0C
143	8F	Maximum Positive Voltage Deviation 38.00V = 3800 (x10mV) = 0ED8H, 2 Bytes Sequence	216	D8
144	90		14	0E
145	91	Ripple and Noise pk-pk (mV) 360mV = 0168H, 2 Bytes Sequence	104	68
146	92		1	01
147	93	Minimum Current Draw (10mA) 0000 = 000AH, 2 Bytes Sequence	0	0
148	94		0	0
149	95	Minimum Current Draw (10mA) , 0000 = 0000H 16.7A = 1670 (x10mA) = 0686H	134	86
150	96		6	06
5VSB OUTPUT RECORD HEADER				
151	97	Record type ID (0x01 = DC Output)	1	01
152	98	End of List /Record Format Version Number for 5VSB Output Record	2	02
153	99	Record Length: 13 Bytes	13	0D
154	9A	Record CHECKSUM of 5VSB Output Record (Zero CHECKSUM)	214	D6
155	9B	(256-(sum of bytes 156 to 168)) Header CHECKSUM of 5VSB Output Record Header (Zero CHECKSUM) (256-(sum of bytes 151 to 154))	26	1A
156	9C	Output Information , 002 = 02H Bit 7: Standby Information = 1B Bits 6-4: Reserved, Write as 000B Bits 3-0: Output Number 2 = 010B	130	82
157	9D	Nominal Voltage 5.00V = 2500(x10mA) = 01F4H, 2 Bytes Sequence	244	F4
158	9E		1	01
159	9F	Maximum Negative Voltage Deviation 4.75V = 525 (x10mV) = 01DBH, 2 Bytes Sequence	219	DB
160	A0		1	01
161	A1	Maximum Positive Voltage Deviation 5.25V = 525(x10mA) = 020DH, 2 Bytes Sequence	13	0D
162	A2		2	02
163	A3	Ripple And Noise pk-pk (mV) 50mV = 0032H, 2 Bytes Sequence	50	32
164	A4		0	00
165	A5	Minimum Current Draw (10mA) 0000 = 000AH, 2 Bytes Sequence	0	0A
166	A6		0	00
167	A7	Maximum Current Draw (10mA) , (6.0A / 10mA) 600 = 0258H 0150 = 0096H, 2 Bytes Sequence	150	96
168	A8		0	00

COMMUNICATION BUS DESCRIPTIONS

LCC600-36U-9P FRU (EEPROM) Data:

OFFSET		DEFINITION (REMARKS)	SPEC VALUE	
(DEC)	(HEX)		(DEC)	(HEX)
OEM RECORD HEADER				
169	A9	Record type = C0H for OEM Record	192	C0
170	AA	End of List /Record Format Version Number for 5V _{SB} output Record	130	82
171	AB	Record Length of OEM Record	42	2A
172	AC	Record CHECKSUM of OEM Record (Zero CHECKSUM)	0	00
173	AD	Header CHECKSUM of OEM Record Header (Zero CHECKSUM) (256-(sum of bytes 169 to 172))	148	94
OEM RECORD				
174	AE	Manufacturer ID (3 bytes, Default is 0)	0	00
175	AF	RESERVED	0	00
176	B0	RESERVED	0	00
177	B1	RESERVED	0	00
178	B2	RESERVED	0	00
179	B3	RESERVED	0	00
180	B4	RESERVED	0	00
181	B5	RESERVED	0	00
182	B6	RESERVED	0	00
183	B7	RESERVED	0	00
184	B8	RESERVED	0	00
185	B9	RESERVED	0	00
186	BA	RESERVED	0	00
187	BB	RESERVED	0	00
188	BC	RESERVED	0	00
189	BD	RESERVED	0	00
190	BE	RESERVED	0	00
191	BF	RESERVED	0	00
192	C0	RESERVED	0	00
193	C1	RESERVED	0	00
194	C2	RESERVED	0	00
195	C3	RESERVED	0	00
196	C4	RESERVED	0	00
197	C5	RESERVED	0	00
198	C6	RESERVED	0	00
199	C7	RESERVED	0	00
200	C8	RESERVED	0	00
201	C9	RESERVED	0	00
202	CA	RESERVED	0	00
203	CB	RESERVED	0	00
204	CC	RESERVED	0	00
205	CD	RESERVED	0	00
206	CE	RESERVED	0	00
207	CF	RESERVED	0	00
208	D0	RESERVED	0	00
209	D1	RESERVED	0	00
210	D2	RESERVED	0	00
211	D3	RESERVED	0	00
212	D4	RESERVED	0	00
213	D5	RESERVED	0	00
214	D6	RESERVED	0	00
215	D7	RESERVED	0	00

COMMUNICATION BUS DESCRIPTIONS

LCC600-36H-9P FRU (EEPROM) Data:

OFFSET		DEFINITION (REMARKS)	SPEC VALUE	
(DEC)	(HEX)		(DEC)	(HEX)
COMMON HEADER, 8 BYTES				
0	00	FORMAT VERSION NUMBER (Common Header) 7:4 - Reserved, write as 0000b 3:0 - Format Version Number = 1h for this specification	1	01
1	01	INTERNAL USE AREA OFFSET	27	1B
2	02	CHASSIS INFO AREA OFFSET	1	01
3	03	BOARD INFO AREA OFFSET	0	00
4	04	PRODUCT INFO AREA OFFSET	5	05
5	05	MULTI RECORD AREA OFFSET	13	0D
6	06	PAD (reserved) Default value is 0.	0	00
7	07	ZERO CHECK SUM (256 - (Sum of bytes 0 to 6))	209	D1
CHASSIS INFO AREA(32 BYTES)				
8	08	FORMAT VERSION NUMBER 7:4 - Reserved, write as 0000b 3:0 - Format Version Number = 1h for this specification	1	01
9	09	CHASSIS INFO AREA LENGTH in multiple of 8 bytes	4	04
10	0A	CHASSIS TYPE (Default value is 0.)	0	00
11	0B	CHASSIS PART NUMBER Type/Length CAh (if used) Type = "ASCII+LATIN1" = (11)b Length = 10 Bytes = (001010)b	193	C1
12	0C	Reserved	0	00
13	0D	Reserved	0	00
14	0E	Reserved	0	00
15	0F	Reserved	0	00
16	10	Reserved	0	00
17	11	Reserved	0	00
18	12	Reserved	0	00
19	13	Reserved	0	00
20	14	Reserved	0	00
21	15	Reserved	0	00
22	16	Reserved	0	00
23	17	Reserved	0	00
24	18	Reserved	0	00
25	19	Reserved	0	00
26	1A	Reserved	0	00
27	1B	Reserved	0	00
28	1C	Reserved	0	00
29	1D	Reserved	0	00
30	1E	Reserved	0	00

COMMUNICATION BUS DESCRIPTIONS

LCC600-36H-9P FRU (EEPROM) Data:

OFFSET		DEFINITION (REMARKS)	SPEC VALUE	
(DEC)	(HEX)		(DEC)	(HEX)
31	1F	Reserved	0	00
32	20	Reserved	0	00
33	21	Reserved	0	00
34	22	Reserved	0	00
35	23	Reserved	0	00
36	24	Reserved	0	00
37	25	Reserved	0	00
38	26	END TAG	0	00
39	27	ZERO CHECK SUM (256 – (Sum of bytes offset 8h to 26h))	58	3A
PRODUCT INFORMATION AREA				
40	28	FORMAT VERSION NUMBER (Product Info Area) 7:4 – Reserved, write as 0000b 3:0 – Format Version Number =1h for this specification	1	01
41	29	PRODUCT INFO AREA LENGTH (In multiples of 8 bytes)	8	08
42	2A	Language (English)	25	19
43	2B	MANUFACTURER NAME TYPE / LENGTH 7:6 – (11)b, 8-Bit ASCII + Latin 1, 5:0 – (000111)b, 7-Byte Allocation	199	C7
		MANUFACTURER'S NAME 7 byte sequence "ARTESYN"		
44	2C	"A" = 41h	65	41
45	2D	"R" = 52h	82	52
46	2E	"T" = 54h	84	54
47	2F	"E" = 45h	69	45
48	30	"S" = 53h	83	53
49	31	"Y" = 59h	89	59
50	32	"N" = 4Eh	78	4E
51	33	PRODUCT NAME Type/Length (CDh) Type = "ASCII+LATIN1" = (11)b; Length = 13 Bytes = (001101)b	206	CE
		PRODUCT NAME BYTES (14 Byte sequence) "LCC600-36H-9P"		
52	34	"L" = 4Ch	76	4C
53	35	"C" = 43h	67	43
54	36	"C" = 43h	67	43
55	37	"6" = 36h	54	36
56	38	"O" = 30h	48	30
57	39	"O" = 30h	48	30
58	3A	"-" = 2Dh	45	2D
59	3B	"3" = 33h	52	33
60	3C	"6" = 36h	56	36
61	3D	"H" = 36H	72	48
62	3E	"-" = 2Dh	45	2D
63	3F	"9" = 39h	57	39
64	40	"P" = 50h	80	50
65	41	Space = 20h	32	20

COMMUNICATION BUS DESCRIPTIONS

LCC600-36H-9P FRU (EEPROM) Data:

OFFSET		DEFINITION (REMARKS)	SPEC VALUE	
(DEC)	(HEX)		(DEC)	(HEX)
66	42	PRODUCT PART/MODEL NUMBER Type/Length (Cah) Type = "ASCII+LATIN1" = (11)b Length = 10 Bytes = (001010)b	202	CA
67	43	Reserved	0	00
68	44	Reserved	0	00
69	45	Reserved	0	00
70	46	Reserved	0	00
71	47	Reserved	0	00
72	48	Reserved	0	00
73	49	Reserved	0	00
74	4A	Reserved	0	00
75	4B	Reserved	0	00
76	4C	Reserved	0	00
77	4D	PRODUCT VERSION NUMBER Type/Length (C2h) Type = "ASCII+LATIN1" = (11)b Length = 2 bytes = (000010)b	194	C2
		PRODUCT VERSION NUMBER BYTES Refer to BOM TLA for latest revision		
78	4E	"A"	65	41
79	4F	"A"	65	41
80	50	PRODUCT SERIAL NUMBER Type/Length Type = "ASCII+LATIN1" = (11)b Length = 13 bytes = (001101)b	205	CD
		PRODUCT SERIAL NUMBER BYTES Model ID = "L293"		
81	51	"L" = 4Ch	75	4C
82	52	"2" = 32h	56	32
83	53	"9" = 39h	57	39
84	54	"3" = 33h	55	33
		MANUFACTURING YEAR AND WEEK CODE (PER UNIT)		
85	55	"W"	87	57
86	56	"W"	87	57
87	57	UNIQUE SERIAL NUMBER (PER UNIT) "SSSS"	83	53
88	58	In Decimal = 083, 083, 083, 083	83	53
89	59	In Hex = 53H, 53H, 53H, 53H	83	53
90	5A		83	53
		MODEL REVISION (PER UNIT) Artesyn Model Rev, See Latest Model Rev in BOM TLA for latest revision		
91	5B	"A"	65	41
92	5C	"A"	65	41
93	5D	"P" = 50H, (For Laguna, Philippines) MANUFACTURING LOCATION (PER UNIT)	80	50
94	5E	End Tag In Decimal: 193 In Hex: 0C1H	193	C1
95	5F	Reserved	0	00
96	60	Reserved	0	00
97	61	Reserved	0	00
98	62	Reserved	0	00
99	63	Reserved	0	00
100	64	Reserved	0	00
101	65	Reserved	0	00
102	66	Reserved	0	00
103	67	Zero Check Sum (256-(Sum of bytes 28h to 67h) (PER UNIT)	58	3A

COMMUNICATION BUS DESCRIPTIONS

LCC600-36H-9P FRU (EEPROM) Data:

OFFSET		DEFINITION (REMARKS)	SPEC VALUE	
(DEC)	(HEX)		(DEC)	(HEX)
MULTI RECORD AREA				
104	68	Power Supply Record Header (72 Bytes) Record Type ID (0x00 = Power Supply Information)	0	00
105	69	3-0: (0010)b, Record Format Version	2	02
106	6A	Record Length: 24 Bytes	24	18
107	6B	Record Checksum (Zero Checksum From 109d To 132d)	197	C5
108	6C	Header Checksum (Zero Checksum From 104d To 107d)	33	21
POWER SUPPLY RECORD				
109	6D	Overall Capacity of the Power Supply,	88	58
110	6E	15-12: (0000)b, Reserved 11-0: (000111001000)b, 600W = 0258H	2	02
111	6F	15-12: (0000)b, Reserved	138	8A
112	70	11-0: (001000011100)b, 650W = 028AH	2	02
113	71	Inrush Current (Amps)	25	19
114	72	Inrush Interval, 200mS	200	C8
115	73	Low End Input Voltage Range 1(10mV)	80	50
116	74	(180V / 10mV) 18000 = 4650H, 2 Bytes Sequence	70	46
117	75	High End Input Voltage Range 1(10mV),	36	24
118	76	(305V/10mV) 30500= 7724H, 2 Bytes Sequence	119	77
119	77	Low End Input Voltage Range 2(10mV)	0	00
120	78	Not Applicable (Auto switch)	0	00
121	79	High End Input Voltage Range 2(10mV)	0	00
122	7A	Not Applicable (Auto switch)	0	00
123	7B	Low End Input Frequency Range, 47Hz = 2FH	47	2F
124	7C	Low End Input Frequency Range, 63Hz = 3FH	63	3F
125	7D	AC Dropout Tolerance in ms, 20mS= 14H	20	14
126	7E	Binary Flags,	38	26
127	7F	15-11: (10100)b, Hold up Time in Seconds = 14H 10-0: (01001011000)b, Peak Capacity in Watts =258H	88	58
128	80		162	A2
129	81	Byte 1 : Bits7-4 ; Voltage 1 Bits3-0 : Voltage2	0	00
130	82	Byte 2 and Byte 3: Total Combined Wattage	0	00
131	83	Stored with LSB first then MSB. Not Applicable	0	00
132	84	Predictive Fail Tachometer Lower Threshold, Not applicable	0	00
48V DC OUTPUT RECORD HEADER				
133	85	Record Type ID (0x01 = DC Output)	1	01
134	86	End Of List/Record Format Version Number	2	02
135	87	Record Length: 13 Bytes	13	0D

COMMUNICATION BUS DESCRIPTIONS

LCC600-36H-9P FRU (EEPROM) Data:

OFFSET		DEFINITION (REMARKS)	SPEC VALUE	
(DEC)	(HEX)		(DEC)	(HEX)
136	88	Record Checksum (Zero Checksum From 138d To 150d)	122	7A
137	89	Header Checksum (Zero Checksum From 133d To 136d)	118	76
36V OUTPUT RECORD				
138	8A	Output Information , 001 = 01H, +36V Output Information	1	01
139	8B	Nominal Voltage 36.00V = 3600 (x10mV) = 0E10H	16	10
140	8C		14	0E
141	8D	Maximum Negative Voltage Deviation 32.00V = 3200 (x10mV) = 0C80H, 2 Bytes Sequence	128	80
142	8E		12	0C
143	8F	Maximum Positive Voltage Deviation 38.00V = 3800 (x10mV) = 0ED8H, 2 Bytes Sequence	216	D8
144	90		14	0E
145	91	Ripple and Noise pk-pk (mV) 360mV = 0168H, 2 Bytes Sequence	104	68
146	92		1	01
147	93	Minimum Current Draw (10mA) 0000 = 000AH, 2 Bytes Sequence	0	0
148	94		0	0
149	95	Minimum Current Draw (10mA) , 0000 = 0000H 16.7A = 1670 (x10mA) = 0686H	134	86
150	96		6	06
5VSB OUTPUT RECORD HEADER				
151	97	Record type ID (0x01 = DC Output)	1	01
152	98	End of List /Record Format Version Number for 5VSB Output Record	2	02
153	99	Record Length: 13 Bytes	13	0D
154	9A	Record CHECKSUM of 5VSB Output Record (Zero CHECKSUM) (256-(sum of bytes 156 to 168))	214	D6
155	9B	Header CHECKSUM of 5VSB Output Record Header (Zero CHECKSUM) (256-(sum of bytes 151 to 154))	26	1A
156	9C	Output Information , 002 = 02H Bit 7: Standby Information = 1B Bits 6-4: Reserved, Write as 000B Bits 3-0: Output Number 2 = 010B	130	82
157	9D	Nominal Voltage 5.00V = 2500(x10mA) = 01F4H, 2 Bytes Sequence	244	F4
158	9E		1	01
159	9F	Maximum Negative Voltage Deviation 4.75V = 525 (x10mV) = 01DBH, 2 Bytes Sequence	219	DB
160	A0		1	01
161	A1	Maximum Positive Voltage Deviation 5.25V = 525(x10mA) = 020DH, 2 Bytes Sequence	13	0D
162	A2		2	02
163	A3	Ripple And Noise pk-pk (mV) 50mV = 0032H, 2 Bytes Sequence	50	32
164	A4		0	00
165	A5	Minimum Current Draw (10mA) 0000 = 000AH, 2 Bytes Sequence	0	00
166	A6		0	00
167	A7	Maximum Current Draw (10mA) , (6.0A / 10mA) 600 = 0258H 0150 = 0096H, 2 Bytes Sequence	150	96
168	A8		0	00

COMMUNICATION BUS DESCRIPTIONS

LCC600-36H-9P FRU (EEPROM) Data:

OFFSET		DEFINITION (REMARKS)	SPEC VALUE	
(DEC)	(HEX)		(DEC)	(HEX)
OEM RECORD HEADER				
169	A9	Record type = C0H for OEM Record	192	C0
170	AA	End of List /Record Format Version Number for 5V V _{SB} output Record	130	82
171	AB	Record Length of OEM Record	42	2A
172	AC	Record CHECKSUM of OEM Record (Zero CHECKSUM)	0	00
173	AD	Header CHECKSUM of OEM Record Header (Zero CHECKSUM) (256-(sum of bytes 169 to 172))	148	94
OEM RECORD				
174	AE	Manufacturer ID (3 bytes, Default is 0)	0	00
175	AF	RESERVED	0	00
176	B0	RESERVED	0	00
177	B1	RESERVED	0	00
178	B2	RESERVED	0	00
179	B3	RESERVED	0	00
180	B4	RESERVED	0	00
181	B5	RESERVED	0	00
182	B6	RESERVED	0	00
183	B7	RESERVED	0	00
184	B8	RESERVED	0	00
185	B9	RESERVED	0	00
186	BA	RESERVED	0	00
187	BB	RESERVED	0	00
188	BC	RESERVED	0	00
189	BD	RESERVED	0	00
190	BE	RESERVED	0	00
191	BF	RESERVED	0	00
192	C0	RESERVED	0	00
193	C1	RESERVED	0	00
194	C2	RESERVED	0	00
195	C3	RESERVED	0	00
196	C4	RESERVED	0	00
197	C5	RESERVED	0	00
198	C6	RESERVED	0	00
199	C7	RESERVED	0	00
200	C8	RESERVED	0	00
201	C9	RESERVED	0	00
202	CA	RESERVED	0	00
203	CB	RESERVED	0	00
204	CC	RESERVED	0	00
205	CD	RESERVED	0	00
206	CE	RESERVED	0	00
207	CF	RESERVED	0	00
208	D0	RESERVED	0	00
209	D1	RESERVED	0	00
210	D2	RESERVED	0	00
211	D3	RESERVED	0	00
212	D4	RESERVED	0	00
213	D5	RESERVED	0	00
214	D6	RESERVED	0	00
215	D7	RESERVED	0	00

COMMUNICATION BUS DESCRIPTIONS

LCC600-48U-9P FRU (EEPROM) Data:

OFFSET		DEFINITION (REMARKS)	SPEC VALUE	
(DEC)	(HEX)		(DEC)	(HEX)
COMMON HEADER, 8 BYTES				
0	00	FORMAT VERSION NUMBER (Common Header) 7:4 - Reserved, write as 0000b 3:0 - Format Version Number = 1h for this specification	1	01
1	01	INTERNAL USE AREA OFFSET	27	1B
2	02	CHASSIS INFO AREA OFFSET	1	01
3	03	BOARD INFO AREA OFFSET	0	00
4	04	PRODUCT INFO AREA OFFSET	5	05
5	05	MULTI RECORD AREA OFFSET	13	0D
6	06	PAD (reserved) Default value is 0.	0	00
7	07	ZERO CHECK SUM (256 – (Sum of bytes 0 to 6))	209	D1
CHASSIS INFO AREA(32 BYTES)				
8	08	FORMAT VERSION NUMBER 7:4 - Reserved, write as 0000b 3:0 - Format Version Number = 1h for this specification	1	01
9	09	CHASSIS INFO AREA LENGTH in multiple of 8 bytes	4	04
10	0A	CHASSIS TYPE (Default value is 0.)	0	00
11	0B	CHASSIS PART NUMBER Type/Length CAh (if used) Type = "ASCII+LATIN1" = (11)b Length = 10 Bytes = (001010)b	193	C1
12	0C	Reserved	0	00
13	0D	Reserved	0	00
14	0E	Reserved	0	00
15	0F	Reserved	0	00
16	10	Reserved	0	00
17	11	Reserved	0	00
18	12	Reserved	0	00
19	13	Reserved	0	00
20	14	Reserved	0	00
21	15	Reserved	0	00
22	16	Reserved	0	00
23	17	Reserved	0	00
24	18	Reserved	0	00
25	19	Reserved	0	00
26	1A	Reserved	0	00
27	1B	Reserved	0	00
28	1C	Reserved	0	00
29	1D	Reserved	0	00
30	1E	Reserved	0	00

COMMUNICATION BUS DESCRIPTIONS

LCC600-48U-9P FRU (EEPROM) Data:

OFFSET		DEFINITION (REMARKS)	SPEC VALUE	
(DEC)	(HEX)		(DEC)	(HEX)
31	1F	Reserved	0	00
32	20	Reserved	0	00
33	21	Reserved	0	00
34	22	Reserved	0	00
35	23	Reserved	0	00
36	24	Reserved	0	00
37	25	Reserved	0	00
38	26	END TAG	0	00
39	27	ZERO CHECK SUM (256 – (Sum of bytes offset 8h to 26h))	58	3A
PRODUCT INFORMATION AREA				
40	28	FORMAT VERSION NUMBER (Product Info Area) 7:4 – Reserved, write as 0000b 3:0 – Format Version Number =1h for this specification	1	01
41	29	PRODUCT INFO AREA LENGTH (In multiples of 8 bytes)	8	08
42	2A	Language (English)	25	19
43	2B	MANUFACTURER NAME TYPE / LENGTH 7:6 - (11)b, 8-Bit ASCII + Latin 1, 5:0 - (000111)b, 7-Byte Allocation	199	C7
		MANUFACTURER'S NAME 7 byte sequence "ARTESYN"		
44	2C	"A" = 41h	65	41
45	2D	"R" = 52h	82	52
46	2E	"T" = 54h	84	54
47	2F	"E" = 45h	69	45
48	30	"S" = 53h	83	53
49	31	"Y" = 59h	89	59
50	32	"N" = 4Eh	78	4E
51	33	PRODUCT NAME Type/Length (CDh) Type = "ASCII+LATIN1" = (11)b; Length = 13 Bytes = (001101)b	206	CE
		PRODUCT NAME BYTES (14 Byte sequence) "LCC600-48U-9P"		
52	34	"L" = 4Ch	76	4C
53	35	"C" = 43h	67	43
54	36	"C" = 43h	67	43
55	37	"6" = 36h	54	36
56	38	"O" = 30h	48	30
57	39	"O" = 30h	48	30
58	3A	"-" = 2Dh	45	2D
59	3B	"4" = 34h	52	34
60	3C	"8" = 38h	56	38
61	3D	"U" = 55h	85	55
62	3E	"-" = 2Dh	45	2D
63	3F	"9" = 39h	57	39
64	40	"P" = 50h	80	50
65	41	Space = 20h	32	20

COMMUNICATION BUS DESCRIPTIONS

LCC600-48U-9P FRU (EEPROM) Data:

OFFSET		DEFINITION	SPEC VALUE	
(DEC)	(HEX)	(REMARKS)	(DEC)	(HEX)
66	42	PRODUCT PART/MODEL NUMBER Type/Length (Cah) Type = "ASCII+LATIN1" = (11)b Length = 10 Bytes = (001010)b	202	CA
67	43	Reserved	0	00
68	44	Reserved	0	00
69	45	Reserved	0	00
70	46	Reserved	0	00
71	47	Reserved	0	00
72	48	Reserved	0	00
73	49	Reserved	0	00
74	4A	Reserved	0	00
75	4B	Reserved	0	00
76	4C	Reserved	0	00
77	4D	PRODUCT VERSION NUMBER Type/Length (C2h) Type = "ASCII+LATIN1" = (11)b Length = 2 bytes = (000010)b	194	C2
		PRODUCT VERSION NUMBER BYTES Refer to BOM TLA for latest revision		
78	4E	"A"	65	41
79	4F	"A"	65	41
80	50	PRODUCT SERIAL NUMBER Type/Length Type = "ASCII+LATIN1" = (11)b Length = 13 bytes = (001101)b	205	CD
		PRODUCT SERIAL NUMBER BYTES Model ID = "K895"		
81	51	"K" = 4Bh	75	4B
82	52	"8" = 38h	56	38
83	53	"9" = 39h	57	39
84	54	"5" = 35h	53	35
		MANUFACTURING YEAR AND WEEK CODE (PER UNIT)		
85	55	"W"	87	57
86	56	"W"	87	57
87	57	UNIQUE SERIAL NUMBER (PER UNIT) "SSSS"	83	53
88	58	In Decimal = 083, 083, 083, 083	83	53
89	59	In Hex = 53H, 53H, 53H, 53H	83	53
90	5A		83	53
		MODEL REVISION (PER UNIT) Artesyn Model Rev, See Latest Model Rev in BOM TLA for latest revision		
91	5B	"A"	65	41
92	5C	"A"	65	41
93	5D	"P" = 50H, (For Laguna, Philippines) MANUFACTURING LOCATION (PER UNIT)	80	50
94	5E	End Tag In Decimal: 193 In Hex: 0C1H	193	C1
95	5F	Reserved	0	00
96	60	Reserved	0	00
97	61	Reserved	0	00
98	62	Reserved	0	00
99	63	Reserved	0	00
100	64	Reserved	0	00
101	65	Reserved	0	00
102	66	Reserved	0	00
103	67	Zero Check Sum (256-(Sum of bytes 28h to 67h) (PER UNIT)		

COMMUNICATION BUS DESCRIPTIONS

LCC600-48U-9P FRU (EEPROM) Data:

OFFSET		DEFINITION (REMARKS)	SPEC VALUE	
(DEC)	(HEX)		(DEC)	(HEX)
MULTI RECORD AREA				
104	68	Power Supply Record Header (72 Bytes) Record Type ID (0x00 = Power Supply Information)	0	00
105	69	3-0: (0010)b, Record Format Version	2	02
106	6A	Record Length: 24 Bytes	24	18
107	6B	Record Checksum (Zero Checksum From 109d To 132d)	197	C5
108	6C	Header Checksum (Zero Checksum From 104d To 107d)	33	21
POWER SUPPLY RECORD				
109	6D	Overall Capacity of the Power Supply, 15-12: (0000)b, Reserved	88	58
110	6E	11-0: (000111001000)b, 600W = 0258H	2	02
111	6F	15-12: (0000)b, Reserved	138	8A
112	70	11-0: (001000011100)b, 650W = 028AH	2	02
113	71	Inrush Current (Amps)	25	19
114	72	Inrush Interval, 200mS	200	C8
115	73	Low End Input Voltage Range 1(10mV)	40	28
116	74	(90V / 10mV) 9000 = 2328H, 2 Bytes Sequence	35	23
117	75	High End Input Voltage Range 1(10mV)	32	20
118	76	(264V/10mV) 26400= 6720H, 2 Bytes Sequence	103	67
119	77	Low End Input Voltage Range 2(10mV)	0	00
120	78	Not Applicable (Autoswitch)	0	00
121	79	High End Input Voltage Range 2(10mV)	0	00
122	7A	Not Applicable (Autoswitch)	0	00
123	7B	Low End Input Frequency Range, 47Hz = 2FH	47	2F
124	7C	Low End Input Frequency Range, 63Hz = 3FH	63	3F
125	7D	AC Dropout Tolerance in ms, 20mS= 14H	20	14
126	7E	Binary Flags,	38	26
127	7F	15-11: (10100)b, Hold up Time in Seconds = 14H	88	58
128	80	10-0: (01001011000)b, Peak Capacity in Watts =258H	162	A2
129	81	Byte 1 : Bits7-4 ; Voltage 1 Bits3-0 : Voltage2	0	00
130	82	Byte 2 and Byte 3: Total Combined Wattage	0	00
131	83	Stored with LSB first then MSB. Not Applicable	0	00
132	84	Predictive Fail Tachometer Lower Threshold, Not applicable	0	00
48V DC OUTPUT RECORD HEADER				
133	85	Record Type ID (0x01 = DC Output)	1	01
134	86	End Of List/Record Format Version Number	2	02
135	87	Record Length: 13 Bytes	13	0D

COMMUNICATION BUS DESCRIPTIONS

LCC600-48U-9P FRU (EEPROM) Data:

OFFSET		DEFINITION (REMARKS)	SPEC VALUE	
(DEC)	(HEX)		(DEC)	(HEX)
136	88	Record Checksum (Zero Checksum From 138d To 150d)	248	F8
137	89	Header Checksum (Zero Checksum From 133d To 136d)	248	F8
48V OUTPUT RECORD				
138	8A	Output Information , 001 = 01H, +48V Output Information	1	01
139	8B	Nominal Voltage 48.00V = 4800 (x10mV) = 12C0H	192	C0
140	8C		18	12
141	8D	Maximum Negative Voltage Deviation 44.00V = 4400 (x10mV) = 1130H, 2 Bytes Sequence	48	30
142	8E		17	11
143	8F	Maximum Positive Voltage Deviation 54.00V = 5400 (x10mV) = 1518H, 2 Bytes Sequence	24	18
144	90		21	15
145	91	Ripple and Noise pk-pk (mV) 480mV (x 1mV)= 01E0H, 2 Bytes Sequence	224	E0
146	92		1	01
147	93	Minimum Current Draw (10mA) 0000 = 000AH, 2 Bytes Sequence	0	0A
148	94		0	00
149	95	Minimum Current Draw (10mA) , 0000 = 0000H 12.50A = 1250(x10mA) = 04E2H	226	E2
150	96		4	04
5VSB OUTPUT RECORD HEADER				
151	97	Record type ID (0x01 = DC Output)	1	01
152	98	End of List /Record Format Version Number for 5VSB Output Record	2	02
153	99	Record Length: 13 Bytes	13	0D
154	9A	Record CHECKSUM of 5VSB Output Record (Zero CHECKSUM)	214	D6
155	9B	(256-(sum of bytes 156 to 168)) Header CHECKSUM of 5VSB Output Record Header (Zero CHECKSUM) (256-(sum of bytes 151 to 154))	26	1A
156	9C	Output Information , 002 = 02H Bit 7: Standby Information = 1B Bits 6-4: Reserved, Write as 000B Bits 3-0: Output Number 2 = 010B	130	82
157	9D	Nominal Voltage 5.00V = 2500(x10mA) = 01F4H, 2 Bytes Sequence	244	F4
158	9E		1	01
159	9F	Maximum Negative Voltage Deviation 4.75V = 525 (x10mV) = 01DBH, 2 Bytes Sequence	219	DB
160	A0		1	01
161	A1	Maximum Positive Voltage Deviation 5.25V = 525(x10mA) = 020DH, 2 Bytes Sequence	13	0D
162	A2		2	02
163	A3	Ripple And Noise pk-pk (mV) 50mV = 0032H, 2 Bytes Sequence	50	32
164	A4		0	00
165	A5	Minimum Current Draw (10mA) 0000 = 000AH, 2 Bytes Sequence	0	0A
166	A6		0	00
167	A7	Maximum Current Draw (10mA) , (6.0A / 10mA) 600 = 0258H 0150 = 0096H, 2 Bytes Sequence	150	96
168	A8		0	00

COMMUNICATION BUS DESCRIPTIONS

LCC600-48U-9P FRU (EEPROM) Data:

OFFSET		DEFINITION (REMARKS)	SPEC VALUE	
(DEC)	(HEX)		(DEC)	(HEX)
OEM RECORD HEADER				
169	A9	Record type = C0H for OEM Record	192	C0
170	AA	End of List /Record Format Version Number for 5V V _{SB} output Record	130	82
171	AB	Record Length of OEM Record	42	2A
172	AC	Record CHECKSUM of OEM Record (Zero CHECKSUM)	0	00
173	AD	Header CHECKSUM of OEM Record Header (Zero CHECKSUM) (256-(sum of bytes 169 to 172))	148	94
OEM RECORD				
174	AE	Manufacturer ID (3 bytes, Default is 0)	0	00
175	AF	RESERVED	0	00
176	B0	RESERVED	0	00
177	B1	RESERVED	0	00
178	B2	RESERVED	0	00
179	B3	RESERVED	0	00
180	B4	RESERVED	0	00
181	B5	RESERVED	0	00
182	B6	RESERVED	0	00
183	B7	RESERVED	0	00
184	B8	RESERVED	0	00
185	B9	RESERVED	0	00
186	BA	RESERVED	0	00
187	BB	RESERVED	0	00
188	BC	RESERVED	0	00
189	BD	RESERVED	0	00
190	BE	RESERVED	0	00
191	BF	RESERVED	0	00
192	C0	RESERVED	0	00
193	C1	RESERVED	0	00
194	C2	RESERVED	0	00
195	C3	RESERVED	0	00
196	C4	RESERVED	0	00
197	C5	RESERVED	0	00
198	C6	RESERVED	0	00
199	C7	RESERVED	0	00
200	C8	RESERVED	0	00
201	C9	RESERVED	0	00
202	CA	RESERVED	0	00
203	CB	RESERVED	0	00
204	CC	RESERVED	0	00
205	CD	RESERVED	0	00
206	CE	RESERVED	0	00
207	CF	RESERVED	0	00
208	D0	RESERVED	0	00
209	D1	RESERVED	0	00
210	D2	RESERVED	0	00
211	D3	RESERVED	0	00
212	D4	RESERVED	0	00
213	D5	RESERVED	0	00
214	D6	RESERVED	0	00
215	D7	RESERVED	0	00

COMMUNICATION BUS DESCRIPTIONS

LCC600-48H-9P FRU (EEPROM) Data:

OFFSET		DEFINITION (REMARKS)	SPEC VALUE	
(DEC)	(HEX)		(DEC)	(HEX)
COMMON HEADER, 8 BYTES				
0	00	FORMAT VERSION NUMBER (Common Header) 7:4 - Reserved, write as 0000b 3:0 - Format Version Number = 1h for this specification	1	01
1	01	INTERNAL USE AREA OFFSET	27	1B
2	02	CHASSIS INFO AREA OFFSET	1	01
3	03	BOARD INFO AREA OFFSET	0	00
4	04	PRODUCT INFO AREA OFFSET	5	05
5	05	MULTI RECORD AREA OFFSET	13	0D
6	06	PAD (reserved) Default value is 0.	0	00
7	07	ZERO CHECK SUM (256 – (Sum of bytes 0 to 6))	209	D1
CHASSIS INFO AREA(32 BYTES)				
8	08	FORMAT VERSION NUMBER 7:4 - Reserved, write as 0000b 3:0 - Format Version Number = 1h for this specification	1	01
9	09	CHASSIS INFO AREA LENGTH in multiple of 8 bytes	4	04
10	0A	CHASSIS TYPE (Default value is 0.)	0	00
11	0B	CHASSIS PART NUMBER Type/Length CAh (if used) Type = "ASCII+LATIN1" = (11)b Length = 10 Bytes = (001010)b	193	C1
12	0C	Reserved	0	00
13	0D	Reserved	0	00
14	0E	Reserved	0	00
15	0F	Reserved	0	00
16	10	Reserved	0	00
17	11	Reserved	0	00
18	12	Reserved	0	00
19	13	Reserved	0	00
20	14	Reserved	0	00
21	15	Reserved	0	00
22	16	Reserved	0	00
23	17	Reserved	0	00
24	18	Reserved	0	00
25	19	Reserved	0	00
26	1A	Reserved	0	00
27	1B	Reserved	0	00
28	1C	Reserved	0	00
29	1D	Reserved	0	00
30	1E	Reserved	0	00

COMMUNICATION BUS DESCRIPTIONS

LCC600-48H-9P FRU (EEPROM) Data:

OFFSET		DEFINITION (REMARKS)	SPEC VALUE	
(DEC)	(HEX)		(DEC)	(HEX)
31	1F	Reserved	0	00
32	20	Reserved	0	00
33	21	Reserved	0	00
34	22	Reserved	0	00
35	23	Reserved	0	00
36	24	Reserved	0	00
37	25	Reserved	0	00
38	26	END TAG	0	00
39	27	ZERO CHECK SUM (256 – (Sum of bytes offset 8h to 26h))	58	3A
PRODUCT INFORMATION AREA				
40	28	FORMAT VERSION NUMBER (Product Info Area) 7:4 – Reserved, write as 0000b 3:0 – Format Version Number =1h for this specification	1	01
41	29	PRODUCT INFO AREA LENGTH (In multiples of 8 bytes)	8	08
42	2A	Language (English)	25	19
43	2B	MANUFACTURER NAME TYPE / LENGTH 7:6 – (11)b, 8-Bit ASCII + Latin 1, 5:0 – (000111)b, 7-Byte Allocation	199	C7
		MANUFACTURER'S NAME 7 byte sequence "ARTESYN"		
44	2C	"A" = 41h	65	41
45	2D	"R" = 52h	82	52
46	2E	"T" = 54h	84	54
47	2F	"E" = 45h	69	45
48	30	"S" = 53h	83	53
49	31	"Y" = 59h	89	59
50	32	"N" = 4Eh	78	4E
51	33	PRODUCT NAME Type/Length (CDh) Type = "ASCII+LATIN1" = (11)b; Length = 13 Bytes = (001101)b	206	CE
		PRODUCT NAME BYTES (14 Byte sequence) "LCC600-48H-9P"		
52	34	"L" = 4Ch	76	4C
53	35	"C" = 43h	67	43
54	36	"C" = 43h	67	43
55	37	"6" = 36h	54	36
56	38	"O" = 30h	48	30
57	39	"O" = 30h	48	30
58	3A	"-" = 2Dh	45	2D
59	3B	"4" = 34h	52	34
60	3C	"8" = 38h	56	38
61	3D	"H" = 48h	72	48
62	3E	"-" = 2Dh	45	2D
63	3F	"9" = 39h	57	39
64	40	"P" = 50h	80	50
65	41	Space = 20h	32	20

COMMUNICATION BUS DESCRIPTIONS

LCC600-48H-9P FRU (EEPROM) Data:

OFFSET		DEFINITION (REMARKS)	SPEC VALUE	
(DEC)	(HEX)		(DEC)	(HEX)
66	42	PRODUCT PART/MODEL NUMBER Type/Length (Cah) Type = "ASCII+LATIN1" = (11)b Length = 10 Bytes = (001010)b	202	CA
67	43	Reserved	0	00
68	44	Reserved	0	00
69	45	Reserved	0	00
70	46	Reserved	0	00
71	47	Reserved	0	00
72	48	Reserved	0	00
73	49	Reserved	0	00
74	4A	Reserved	0	00
75	4B	Reserved	0	00
76	4C	Reserved	0	00
77	4D	PRODUCT VERSION NUMBER Type/Length (C2h) Type = "ASCII+LATIN1" = (11)b Length = 2 bytes = (000010)b	194	C2
		PRODUCT VERSION NUMBER BYTES Refer to BOM TLA for latest revision		
78	4E	"A"	65	41
79	4F	"A"	65	41
80	50	PRODUCT SERIAL NUMBER Type/Length Type = "ASCII+LATIN1" = (11)b Length = 13 bytes = (001101)b	205	CD
		PRODUCT SERIAL NUMBER BYTES Model ID = "K897"		
81	51	"K" = 4Bh	75	4B
82	52	"8" = 38h	56	38
83	53	"9" = 39h	57	39
84	54	"7" = 37h	55	37
		MANUFACTURING YEAR AND WEEK CODE (PER UNIT)		
85	55	"W"	87	57
86	56	"W"	87	57
87	57	UNIQUE SERIAL NUMBER (PER UNIT) "SSSS"	83	53
88	58	In Decimal = 083, 083, 083, 083	83	53
89	59	In Hex = 53H, 53H, 53H, 53H	83	53
90	5A		83	53
		MODEL REVISION (PER UNIT) Artesyn Model Rev, See Latest Model Rev in BOM TLA for latest revision		
91	5B	"A"	65	41
92	5C	"A"	65	41
93	5D	"P" = 50H, (For Laguna, Philippines) MANUFACTURING LOCATION (PER UNIT)	80	50
94	5E	End Tag In Decimal: 193 In Hex: 0C1H	193	C1
95	5F	Reserved	0	00
96	60	Reserved	0	00
97	61	Reserved	0	00
98	62	Reserved	0	00
99	63	Reserved	0	00
100	64	Reserved	0	00
101	65	Reserved	0	00
102	66	Reserved	0	00
103	67	Zero Check Sum (256-(Sum of bytes 28h to 67h) (PER UNIT)	58	3A

COMMUNICATION BUS DESCRIPTIONS

LCC600-48H-9P FRU (EEPROM) Data:

OFFSET		DEFINITION (REMARKS)	SPEC VALUE	
(DEC)	(HEX)		(DEC)	(HEX)
MULTI RECORD AREA				
104	68	Power Supply Record Header (72 Bytes) Record Type ID (0x00 = Power Supply Information)	0	00
105	69	3-0: (0010)b, Record Format Version	2	02
106	6A	Record Length: 24 Bytes	24	18
107	6B	Record Checksum (Zero Checksum From 109d To 132d)	197	C5
108	6C	Header Checksum (Zero Checksum From 104d To 107d)	33	21
POWER SUPPLY RECORD				
109	6D	Overall Capacity of the Power Supply, 15-12: (0000)b, Reserved	88	58
110	6E	11-0: (000111001000)b, 600W = 0258H	2	02
111	6F	15-12: (0000)b, Reserved	138	8A
112	70	11-0: (001000011100)b, 650W = 028AH	2	02
113	71	Inrush Current (Amps)	25	19
114	72	Inrush Interval, 200mS	200	C8
115	73	Low End Input Voltage Range 1(10mV) (180V / 10mV) 18000 = 4650H, 2 Bytes Sequence	80	50
116	74		70	46
117	75	High End Input Voltage Range 1(10mV), (305V/10mV) 30500= 7724H, 2 Bytes Sequence	36	24
118	76		119	77
119	77	Low End Input Voltage Range 2(10mV) Not Applicable (Autoswitch)	0	00
120	78		0	00
121	79	High End Input Voltage Range 2(10mV) Not Applicable (Autoswitch)	0	00
122	7A		0	00
123	7B	Low End Input Frequency Range, 47Hz = 2FH	47	2F
124	7C	Low End Input Frequency Range, 63Hz = 3FH	63	3F
125	7D	AC Dropout Tolerance in ms, 20mS= 14H	20	14
126	7E	Binary Flags,	38	26
127	7F	15-11: (10100)b, Hold up Time in Seconds = 14H	88	58
128	80	10-0: (01001011000)b, Peak Capacity in Watts =258H	162	A2
129	81	Byte 1 : Bits7-4 ; Voltage 1 Bits3-0 : Voltage2	0	00
130	82	Byte 2 and Byte 3: Total Combined Wattage	0	00
131	83	Stored with LSB first then MSB. Not Applicable	0	00
132	84	Predictive Fail Tachometer Lower Threshold, Not applicable	0	00
48V DC OUTPUT RECORD HEADER				
133	85	Record Type ID (0x01 = DC Output)	1	01
134	86	End Of List/Record Format Version Number	2	02
135	87	Record Length: 13 Bytes	13	0D

COMMUNICATION BUS DESCRIPTIONS

LCC600-48H-9P FRU (EEPROM) Data:

OFFSET		DEFINITION (REMARKS)	SPEC VALUE	
(DEC)	(HEX)		(DEC)	(HEX)
136	88	Record Checksum (Zero Checksum From 138d To 150d)	248	F8
137	89	Header Checksum (Zero Checksum From 133d To 136d)	248	F8
48V OUTPUT RECORD				
138	8A	Output Information , 001 = 01H, +48V Output Information	1	01
139	8B	Nominal Voltage	192	C0
140	8C	48.00V = 4800 (x10mV) = 12C0H	18	12
141	8D	Maximum Negative Voltage Deviation	48	30
142	8E	44.00V = 4400 (x10mV) = 1130H, 2 Bytes Sequence	17	11
143	8F	Maximum Positive Voltage Deviation	24	18
144	90	54.00V = 5400 (x10mV) = 1518H, 2 Bytes Sequence	21	15
145	91	Ripple and Noise pk-pk (mV)	224	E0
146	92	480mV (x 1mV)= 01E0H, 2 Bytes Sequence	1	01
147	93	Minimum Current Draw (10mA)	0	00
148	94	0000 = 0000H, 2 Bytes Sequence	0	00
149	95	Minimum Current Draw (10mA) , 0000 = 0000H	226	E2
150	96	12.50A = 1250(x10mA) = 04E2H	4	04
5VSB OUTPUT RECORD HEADER				
151	97	Record type ID (0x01 = DC Output)	1	01
152	98	End of List /Record Format Version Number for 5VSB Output Record	2	02
153	99	Record Length: 13 Bytes	13	0D
154	9A	Record CHECKSUM of 5VSB Output Record (Zero CHECKSUM)	214	D6
155	9B	(256-(sum of bytes 156 to 168)) Header CHECKSUM of 5VSB Output Record Header (Zero CHECKSUM) (256-(sum of bytes 151 to 154))	26	1A
156	9C	Output Information , 002 = 02H Bit 7: Standby Information = 1B Bits 6-4: Reserved, Write as 000B Bits 3-0: Output Number 2 = 010B	130	82
157	9D	Nominal Voltage	244	F4
158	9E	5.00V = 2500(x10mA) = 01F4H, 2 Bytes Sequence	1	01
159	9F	Maximum Negative Voltage Deviation	219	DB
160	A0	4.75V = 525 (x10mV) = 01DBH, 2 Bytes Sequence	1	01
161	A1	Maximum Positive Voltage Deviation	13	0D
162	A2	5.25V = 525(x10mA) = 020DH, 2 Bytes Sequence	2	02
163	A3	Ripple And Noise pk-pk (mV)	50	32
164	A4	50mV = 0032H, 2 Bytes Sequence	0	00
165	A5	Minimum Current Draw (10mA)	0	00
166	A6	0000 = 000AH, 2 Bytes Sequence	0	00
167	A7	Maximum Current Draw (10mA) , (6.0A / 10mA) 600 = 0258H	150	96
168	A8	0150 = 0096H, 2 Bytes Sequence	0	00

COMMUNICATION BUS DESCRIPTIONS

LCC600-48H-9P FRU (EEPROM) Data:

OFFSET		DEFINITION (REMARKS)	SPEC VALUE	
(DEC)	(HEX)		(DEC)	(HEX)
OEM RECORD HEADER				
169	A9	Record type = C0H for OEM Record	192	C0
170	AA	End of List /Record Format Version Number for 5V V_{SB} output Record	130	82
171	AB	Record Length of OEM Record	42	2A
172	AC	Record CHECKSUM of OEM Record (Zero CHECKSUM)	0	00
173	AD	Header CHECKSUM of OEM Record Header (Zero CHECKSUM) (256-(sum of bytes 169 to 172))	148	94
OEM RECORD				
174	AE	Manufacturer ID (3 bytes, Default is 0)	0	00
175	AF	RESERVED	0	00
176	B0	RESERVED	0	00
177	B1	RESERVED	0	00
178	B2	RESERVED	0	00
179	B3	RESERVED	0	00
180	B4	RESERVED	0	00
181	B5	RESERVED	0	00
182	B6	RESERVED	0	00
183	B7	RESERVED	0	00
184	B8	RESERVED	0	00
185	B9	RESERVED	0	00
186	BA	RESERVED	0	00
187	BB	RESERVED	0	00
188	BC	RESERVED	0	00
189	BD	RESERVED	0	00
190	BE	RESERVED	0	00
191	BF	RESERVED	0	00
192	C0	RESERVED	0	00
193	C1	RESERVED	0	00
194	C2	RESERVED	0	00
195	C3	RESERVED	0	00
196	C4	RESERVED	0	00
197	C5	RESERVED	0	00
198	C6	RESERVED	0	00
199	C7	RESERVED	0	00
200	C8	RESERVED	0	00
201	C9	RESERVED	0	00
202	CA	RESERVED	0	00
203	CB	RESERVED	0	00
204	CC	RESERVED	0	00
205	CD	RESERVED	0	00
206	CE	RESERVED	0	00
207	CF	RESERVED	0	00
208	D0	RESERVED	0	00
209	D1	RESERVED	0	00
210	D2	RESERVED	0	00
211	D3	RESERVED	0	00
212	D4	RESERVED	0	00
213	D5	RESERVED	0	00
214	D6	RESERVED	0	00
215	D7	RESERVED	0	00

PMBUS™ SPECIFICATIONS

The LCC600 series is compliant with the industry standard PMBus™ protocol for monitoring and control of the power supply via the I²C interface port.

LCC600 Series PMBus™ General Instructions

Equipment Setup

The following is typical I²C communication setup:

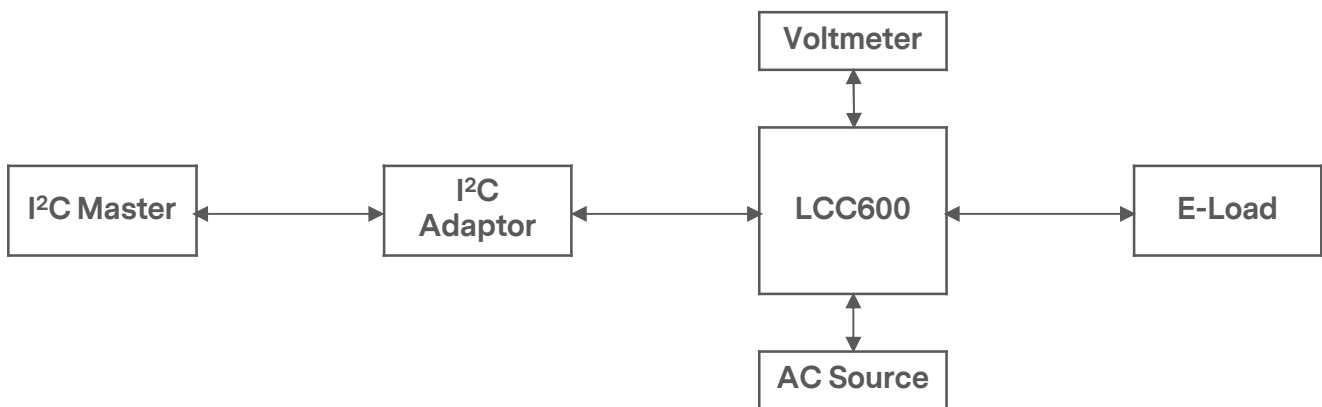

PMBus™ Writing Instructions

When writing to any PMBus™ R/W registers, ALWAYS do the following:

Disable Write Protect (command 10h) by writing any of the following accordingly:

Levels: 00h - Enable writing to all writeable commands

20h - Disables write except 10h, 01h, 00h, 02h and 21h commands

40h - Disables write except 10h, 01h, and 00h commands

80h - Disable write except 0x00h

To save changes on the USER PMBus™ Table:

Use send byte command: 15h STORE_USER_ALL

Wait for 5 seconds, turn-off the PSU, wait for another 5 seconds before turning it on.

PMBUS™ SPECIFICATIONS

The LCC600 Series Supported PMBus™ Command List:

Command Code	Command Name	Default Value	Access Type	Data Bytes	Data Format	Description
00h	PAGE	00h	R	1	Hex	
01h	OPERATION	80h	R/W	1	Bitmapped	Used to turn the unit ON/OFF in conjunction with the input CONTROL pin.
	b7:6 7 - Unit ON 6 - Soft Off	10b				00 - INVALID INPUT 01 - PSU OFF 10 - PSU ON (Default) 11 - INVALID INPUT
	b5:4 5 - Margin High 4 - Margin Low	00b				00 - VALID INPUT (Default)
	b3:2 3 - Margin Act on Fault 2 - Margin Ignore Fault	00b				00 - VALID INPUT (Default)
	b1:0 Reserved	00b				00 - VALID INPUT (Default)
02h	ON_OFF_CONFIG	1Eh	R	1	Bitmapped	Configures the combination of CONTROL pin and serial communication commands needed to turn the unit ON/OFF.
	b7:5	00b				Default
	b4 - Control pin and Serial communication control	1				1 - Unit powers up as dictated by CONTROL pin and OPERATION command
	b3 - Serial communication Control	1				1 - Enables Serial communication ON/OFF portion of OPERATION command. Requires CONTROL pin to be asserted for the unit to start and energize the output.
	b2 - Control pin	1				1 - Unit requires CONTROL pin to be asserted to start the unit.
	b1 - Control pin polarity	0				1 - Active high (Pull high to start the unit).
	b0 - Control pin action	0				0 - Use programmed turn ON/OFF delay
03h	CLEAR_FAULTS	N/A	S	1	N/A	
10h	WRITE_PROTECT	80h	R/W	1	Bitmapped	Used to Control Writing to the PMBus Device 80h - Disables write except 10h 40h - Disables write except 10h, 01h, 00h 20h - Disables write except 10h,01h,00h,02h and 21h commands 00 - Enables write to all writeable commands.
20h	VOUT_MODE	17h	R	1	N/A	Specifies the mode and parameters of Output Voltage related Data Formats

PMBUS™ SPECIFICATIONS

The LCC600 Series Supported PMBus™ Command List:

Command Code	Command Name	Default Value	Access Type	Data Bytes	Data Format	Description
21h	VOUT_COMMAND	0000	R/W	2	Linear (VOUT)	"Sets the Output Voltage Reference Vout command sends discreet value to change output voltage" Note: that setpoint will not work once vout command is set. To enable setpoint again write 0 value. LCC600-12 Default: 12V Min: 12V Max: 15V LCC600-28 Default: 28V Min: 24V Max: 30V LCC600-36 Default: 36V Min: 32V Max: 38V LCC600-48 Default: 48V Min: 44V Max: 54V
35h	VIN_ON	EAB8	R	2	Linear	Sets the value of input, in volts, at which the unit should start. AC GOOD LCC600-12U Default: 87Vac LCC600-12H Default: 175Vac LCC600-28U Default: 87Vac LCC600-28H Default: 175Vac LCC600-36U Default: 87Vac LCC600-36H Default: 175Vac LCC600-48U Default: 87Vac LCC600-48H Default: 175Vac
36h	VIN_OFF	EA88	R	2	Linear	Sets the value of input, in volts, at which the unit should stop power conversion. AC BAD LCC600-12U Default: 81Vac LCC600-12H Default: 165Vac LCC600-28U Default: 81Vac LCC600-28H Default: 165Vac LCC600-36U Default: 81Vac LCC600-36H Default: 165Vac LCC600-48U Default: 81Vac LCC600-48H Default: 165Vac
40h	VOUT_OV_FAULT_LIMIT	7A00	R	2	Linear	LCC600-12 Default: 15.6V, 128%-132% of output Voltage LCC600-28 Default: 36.4V, 128%-132% of output Voltage LCC600-36 Default: 47V, 128%-132% of output Voltage LCC600-48 Default: 61V, 125%-129% of output Voltage
42h	VOUT_OV_WARN_LIMIT	7200	R	2	Linear	LCC600-12 Default: 13V, 108%-112% of output Voltage LCC600-28 Default: 31V, 108%-112% of output Voltage LCC600-36 Default: 40V, 108%-112% of output Voltage LCC600-48 Default: 57V, 116%-120% of output Voltage

PMBUS™ SPECIFICATIONS

The LCC600 Series Supported PMBus™ Command List:

Command Code	Command Name	Default Value	Access Type	Data Bytes	Data Format	Description
44h	VOUT_UV_FAULT_LIMIT	500A	R	2	Linear	LCC600-12 Default: 9V, 73%-77% of output Voltage LCC600-28 Default: 21V, 73%-77% of output Voltage LCC600-36 Default: 27V, 73%-77% of output Voltage LCC600-48 Default: 40V, 81%-85% of output Voltage
46h	IOUT_OC_FAULT_LIMIT	DB40	R	2	Linear	LCC600-12 Default: 60A, 119%-123% of output Voltage LCC600-28 Default: 26A, 119%-123% of output Voltage LCC600-36 Default: 20A, 119%-123% of output Voltage LCC600-48 Default: 14.5A, 114%-118% of output Voltage
4Ah	IOUT_OC_WARN_LIMIT	DAE0	R	2	Linear	LCC600-12 Default: 53.5A, 105%-109% of rated output current LCC600-28 Default: 23A, 105%-109% of rated output current LCC600-36 Default: 18A, 105%-109% of rated output current LCC600-48 Default: 13.5A, 106%-110% of rated output current
4Fh	OT_FAULT_LIMIT	EAB8	R	2	Linear	Secondary ambient temperature Fault threshold, in degree C. (87degC)
51h	OT_WARN_LIMIT	EAB0	R	2	Linear	Secondary ambient temperature warning threshold, in degree C. Operating limit. refer to section 3.1. (86degC)
58h	VIN_UV_WARN_LIMIT	EAB0	R	2	Linear	LCC600-12U Default: 86Vac LCC600-12H Default: 175Vac LCC600-28U Default: 86Vac LCC600-28H Default: 175Vac LCC600-36U Default: 86Vac LCC600-36H Default: 175Vac LCC600-48U Default: 86Vac LCC600-48H Default: 175Vac
59h	VIN_UV_FAULT_LIMIT	EA88	R	2	Linear	LCC600-12U Default: 81Vac LCC600-12H Default: 170Vac LCC600-28U Default: 81Vac LCC600-28H Default: 170Vac LCC600-36U Default: 81Vac LCC600-36H Default: 170Vac LCC600-48U Default: 81Vac LCC600-48H Default: 170Vac
6Ah	POUT_OP_WARN_LIMIT	0262	R	2	Linear	Default

PMBUS™ SPECIFICATIONS

The LCC600 Series Supported PMBus™ Command List:

Command Code	Command Name	Default Value	Access Type	Data Bytes	Data Format	Description
78h	STATUS_BYTE	00	R	1	Bitmapped	PMBUs status bits that are supported in the different status registers
	b7 - BUSY					Not support
	b6 - OFF					Unit is OFF
	b5 - VOUT_OV					Output over-voltage fault has occurred
	b4 - IOUT_OC					Output over-current fault has occurred
	b3 - VIN_UV					An input under-voltage fault has occurred
	b2 - TEMPERATURE					A temperature fault or warning has occurred
	b1 - CML					A communication, memory or logic fault has occurred.
	b0 - NONE OF THE ABOVE					Not support
79h	STATUS_WORD	0000	R	2	Bitmapped	PMBUs status bits that are supported in the different status registers
	b15 - VOUT					An output voltage fault or warning has occurred
	b14 - IOUT/POUT					An Output current or power fault or warning has occurred.
	b13 - INPUT					An input voltage, current or power fault or warning as occurred.
	b12 - MFR					Not support
	b11 - POWER_GOOD#					The POWER_GOOD signal is de-asserted
	b10 - FANS					Not support
	b9 - OTHER					Not support
	b8 - UNKNOWN					Not support
	b7 - BUSY					Not support
	b6 - OFF					Unit is OFF
	b5 - VOUT_OV					Output over-voltage fault has occurred
	b4 - IOUT_OC					Output over-current fault has occurred
	b3 - VIN_UV					An input under-voltage fault has occurred
	b2 - TEMPERATURE					A temperature fault or warning has occurred
	b1 - CML					A communication, memory or logic fault has occurred.
	b0 - NONE_OF_THE_ABOVE					Not support

PMBUS™ SPECIFICATIONS

The LCC600 Series Supported PMBus™ Command List:

Command Code	Command Name	Default Value	Access Type	Data Bytes	Data Format	Description
7Ah	STATUS_VOUT	00	R/W	1	Bitmapped	Output voltage related faults
	b7 - VOUT_OV_FAULT					VOUT Over-voltage Fault
	b6 - VOUT_OV_LV_FAULT					VOUT Over-voltage warning
	b5 - VOUT_UV_WARNING					VOUT Under-voltage Warning
	b4 - VOUT_UV_FAULT					VOUT Under-voltage Fault
	b3 - VOUT_MAX Warning					Not support
	b2 - TON_MAX_FAULT					TON_MAX_FAULT
	b1 - TOFF_MAX_WARNING					Not support
	b0 - VOUT Tracking Error					Not support
7Bh	STATUS_IOUT	00	R/W	1	Bitmapped	Output current related faults
	b7 - IOUT_OC_FAULT					IOUT Over current Fault
	b6 - IOUT_OC_LV_FAULT					Not support
	b5 - IOUT_OC_WARNING					IOUT Overcurrent Warning
	b4 - IOUT_UC_FAULT					Not support
	b3 - Current Share Fault					Not support
	b2 - In Power Limiting Mode					Not support
	b1 - POUT_OP_FAULT					Not support
	b0 - POUT_OP_WARNING					POUT Overpower Warning
7Ch	STATUS_INPUT	00	R/W	1	Bitmapped	Input related faults and warnings
	b7 - VIN_OV_FAULT					VIN Overvoltage Fault
	b6 - VIN_OV_WARNING					VIN Overvoltage Warning
	b5 - VIN_UV_WARNING					VIN Undervoltage Warning
	b4 - VIN_UV_FAULT					VIN Undervoltage Fault
	b3 - Unit Off For Insufficient Input Voltage					Absence of or no input condition (not UV)
	b2 - IIN_OC_FAULT					Not support
	b1 - IIN_OC_WARNING					Not support
	b0 - PIN_OP_WARNING					Not support
7Dh	STATUS_TEMPERATURE	00	R/W	1	Bitmapped	Temperature related faults and warnings
	b7 - OT_FAULT					Overtemperature Fault
	b6 - OT_WARNING					Overtemperature Warning
	b5 - UT_WARNING					Not support
	b4 - UT_FAULT					Not support
	b3 : 0					Not support

PMBUS™ SPECIFICATIONS

The LCC600 Series Supported PMBus™ Command List:

Command Code	Command Name	Default Value	Access Type	Data Bytes	Data Format	Description
7Eh	STATUS_CML	00	R/W	1	Bitmapped	Communications, Logic and Memory
	b7 - Invalid Or Unsupported Command Received					The following conditions shall also assert this flag: - A write transaction on read only commands - A write transaction on a password protected command that is still locked
	b6 - Invalid Or Unsupported Data Received					Packet Error Check Failed
	b5 - Packet Error Check Failed					Memory Fault Detect, CRC Error
	b4 - Memory Fault Detected [1]					Memory Fault Detect, CRC Error
	b3 - Processor Fault Detected [2]					Not support
	b2 - Reserved					Not support
	b1 - A communication fault other than the ones listed in this table has occurred					Not support
b0 - Other Memory Or Logic Fault has occurred. [3]					Not support	
80h	STATUS_MFR_SPECIFIC	00	R/W	1	Bitmapped	Manufacturer Status codes
88h	READ_VIN	-	R	2	Linear	Returns input Voltage in Volts ac.
8Bh	READ_VOUT	-	R	2	Linear	Returns the actual, measured voltage in Volts.
8Ch	READ_IOUT	-	R	2	Linear	Returns the output current in amperes.
8Dh ¹	READ_TEMPERATURE1 (SEC_AMB)	-	R	2	Linear	Secondary Hotspot
8Eh ²	READ_TEMPERATURE2 (SEC_AMB)	-	R	2	Linear	Primary Hotspot
8Fh ³	READ_TEMPERATURE3 (SEC_AMB)	-	R	2	Linear	Primary Hotspot
96h	READ_POOUT	-	R	2	Linear	Returns the output power, in Watts.
98h	PMBUS_REVISION	22h	R	1	Linear	Reads the PMBus revision number
99h	MFR_ID	4E,59,53,45,54,52,41,7	R	7	ASCII	ARTESYN

Note 1 - 8Dh: Maximum allowed temperature is 111 °C. And cold temperature read out limitation is -10 °C.

Note 2 - 8Eh: Maximum allowed temperature is 124 °C. And cold temperature read out limitation is -10 °C.

Note 3 - 8Fh: Maximum allowed temperature is 101 °C. And cold temperature read out limitation is -10 °C.

v

PMBUS™ SPECIFICATIONS

The LCC600 Series Supported PMBus™ Command List:

Command Code	Command Name	Default Value	Access Type	Data Bytes	Data Format	Description
9Ah	MFR_MODEL	4C,43,43,36,30,30,2D,32,38,55,2D,39,50,20	R/W	14	ASCII	Default Value: "LCC600-12U-4P" "LCC600-12U-9P" "LCC600-12H-4P" "LCC600-12H-9P" "LCC600-28U-4P" "LCC600-28U-9P" "LCC600-28H-4P" "LCC600-28H-9P" "LCC600-36U-4P" "LCC600-36U-9P" "LCC600-36H-4P" "LCC600-36H-9P" "LCC600-48U-4P" "LCC600-48U-9P" "LCC600-48H-4P" "LCC600-48H-9P"
9Bh	MFR_REVISION	-	R	2	ASCII	Default: Default value should be BOM TLA (can be found on serial number).
9Ch	MFR_LOCATION	-	R	11	ASCII	Default: "Philippines"
9Dh	MFR_DATE	-	R/W	6	ASCII	Manufacture Date, ASCII format structure : YYMMDD
9Eh	MFR_SERIAL	-	R/W	Varies	ASCII	LCC600-12U-9P Default "L477WWSSSSAAP" LCC600-12U-4P Default "L478WWSSSSAAP" LCC600-12H-9P Default "L479WWSSSSAAP" LCC600-12H-4P Default "L480WWSSSSAAP" LCC600-28U-9P Default "K618WWSSSSAAP" LCC600-28U-4P Default "K619WWSSSSAAP" LCC600-28H-9P Default "K620WWSSSSAAP" LCC600-28H-4P Default "K621WWSSSSAAP" LCC600-36U-9P Default "L291WWSSSSAAP" LCC600-36U-4P Default "L292WWSSSSAAP" LCC600-36H-9P Default "L293WWSSSSAAP" LCC600-36H-4P Default "L295WWSSSSAAP" LCC600-48U-9P Default "K895WWSSSSAAP" LCC600-48U-4P Default "K896WWSSSSAAP" LCC600-48U-9P Default "K897WWSSSSAAP" LCC600-48U-4P Default "K898WWSSSSAAP"

PMBUS™ SPECIFICATIONS

The LCM600 Series Supported PMBus™ Command List:

Command Code	Command Name	Default Value	Access Type	Data Bytes	Data Format	Description
A0h	MFR_VIN_MIN	EAD0	R	2	Linear	Minimum Input Voltage LCC600-12U Default: 90Vac LCC600-12H Default: 180Vac LCC600-28U Default: 90Vac LCC600-28H Default: 180Vac LCC600-36U Default: 90Vac LCC600-36H Default: 180Vac LCC600-48U Default: 90Vac LCC600-48H Default: 180Vac
A1h	MFR_VIN_MAX	FA10	R	2	Linear	Maximum Input Voltage LCC600-12U Default: 264Vac LCC600-12H Default: 305Vac LCC600-28U Default: 264Vac LCC600-28H Default: 305Vac LCC600-36U Default: 264Vac LCC600-36H Default: 305Vac LCC600-48U Default: 264Vac LCC600-48H Default: 305Vac
A2h	MFR_IIN_MAX	D20	R	2	Linear	Maximum Input Current (8A)
A3h	MFR_PIN_MAX	294	R	2	Linear	Maximum Input Power (660W)
A4h	MFR_VOUT_MIN	300	R	2	Linear	Minimum Output Voltage LCC600-12 Default: 12V LCC600-28 Default: 24V LCC600-36 Default: 32V LCC600-48 Default: 44V
A5h	MFR_VOUT_MAX	3C0	R	2	Linear	Maximum Output Voltage LCC600-12 Default: 15V LCC600-28 Default: 30V LCC600-36 Default: 38V LCC600-48 Default: 54V
A6h	MFR_IOUT_MAX	DB20	R	2	Linear	Maximum Output Current LCC600-12 Default: 50A LCC600-28 Default: 21.5A LCC600-36 Default: 16.7A LCC600-48 Default: 12.5A
A7h	MFR_POUT_MAX	258	R	2	Linear	Maximum Output Power (600W)
A8h	MFR_TAMBIENT_MAX	E320	R	2	Linear	Maximum Operating Ambient Temperature (Secondary Ambient) (50 degC)
A9h	MFR_TAMBIENT_MIN	DD80	R	2	Linear	Minimum Operating Ambient Temperature (Secondary Ambient) (-20 degC)
AAh	MFR_EFFICIENCY_LL	-	R	14	Linear	
ABh	MFR_EFFICIENCY_HL	-	R	14	Linear	
E0h	FW_PRI_VERSION	-	R	8	ASCII	Varies
E1h	FW_SEC_VERSION	-	R	8	ASCII	Varies
F1h	ISP_UNLOCK_CODE	-	R/W	4	ASCII	Command available in ISP Mode
F2h	ISP_CTRL_CMD	-	W	1	Bitmapped	Command available in ISP Mode
F3h	ISP_STATUS_BYTE	-	R	1	Bitmapped	Command available in ISP Mode
F4h	ISP_FLASH_ADDR	-	R/W	4	Raw	Command available in ISP Mode
F5h	ISP_FLASH_DATA	-	R/W	4	Raw	Command available in ISP Mode

APPLICATION NOTES

Current Sharing

The LCC600 series main output V1 is equipped with current sharing capability. This will allow up to 5 power supplies to be connected in parallel for higher power application. Current share accuracy is typically 10% of full load. The I²C Line should be connected separately when the number of units in parallel is more than 5. The 5V standby need to be connecter together.

The table below shows the rated Maximum Power capacity when units are in parallel configuration. This is to consider the 10% load sharing tolerance. Max load during start-up in parallel operation is limited to 600W (max power of one supply).

Number of Units in Parallel (N)	Maximum Output power Rated + [(N-1) x 0.8] x Rated, Where: Rated – 600W, N – Number of PSU in Parallel
Stand-alone	600W
2	1080W
3	1560W
4	2040W
5	2520W

The PSU will have an active load sharing percentage as shown below.

Rail Loading (%)	Sharing Percent Error(%)
25%	30%
50%	15%
75%	15%
100%	10%

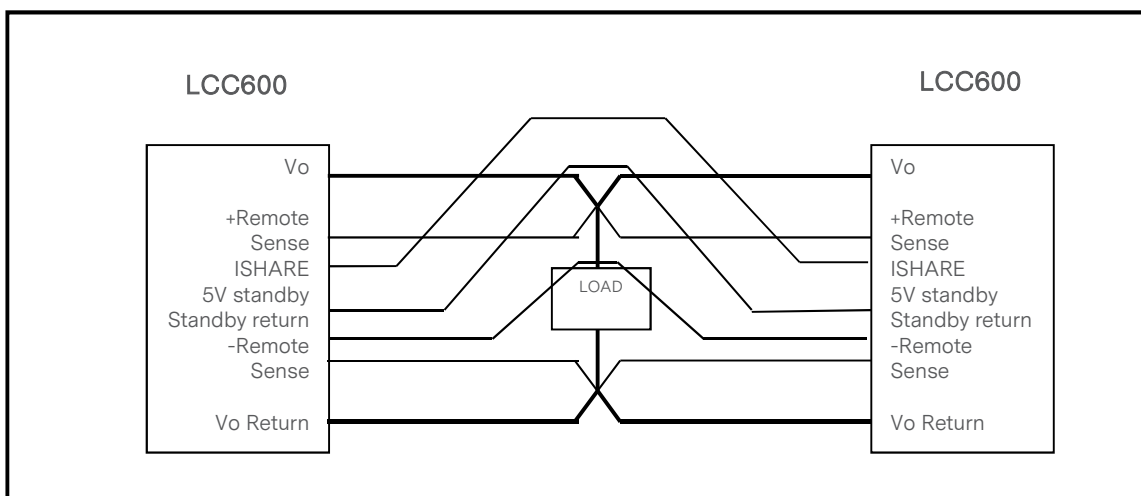

APPLICATION NOTES

Internal Temperature Sensors

The outlined temperature reading by universal PMBUS GUI below shows the internal temperature sensors in the power supply and detail reading values of these sensors. Also the limitations presented to know if the temperature still allowed.

8Dh – Internal secondary output hotspot (near baseplate): Ref as OUTPUT

8Eh – Internal primary hotspot (at FET heatsink): Ref as HEATSINK

8Fh – Internal primary input hotspot (near baseplate): Ref as INPUT

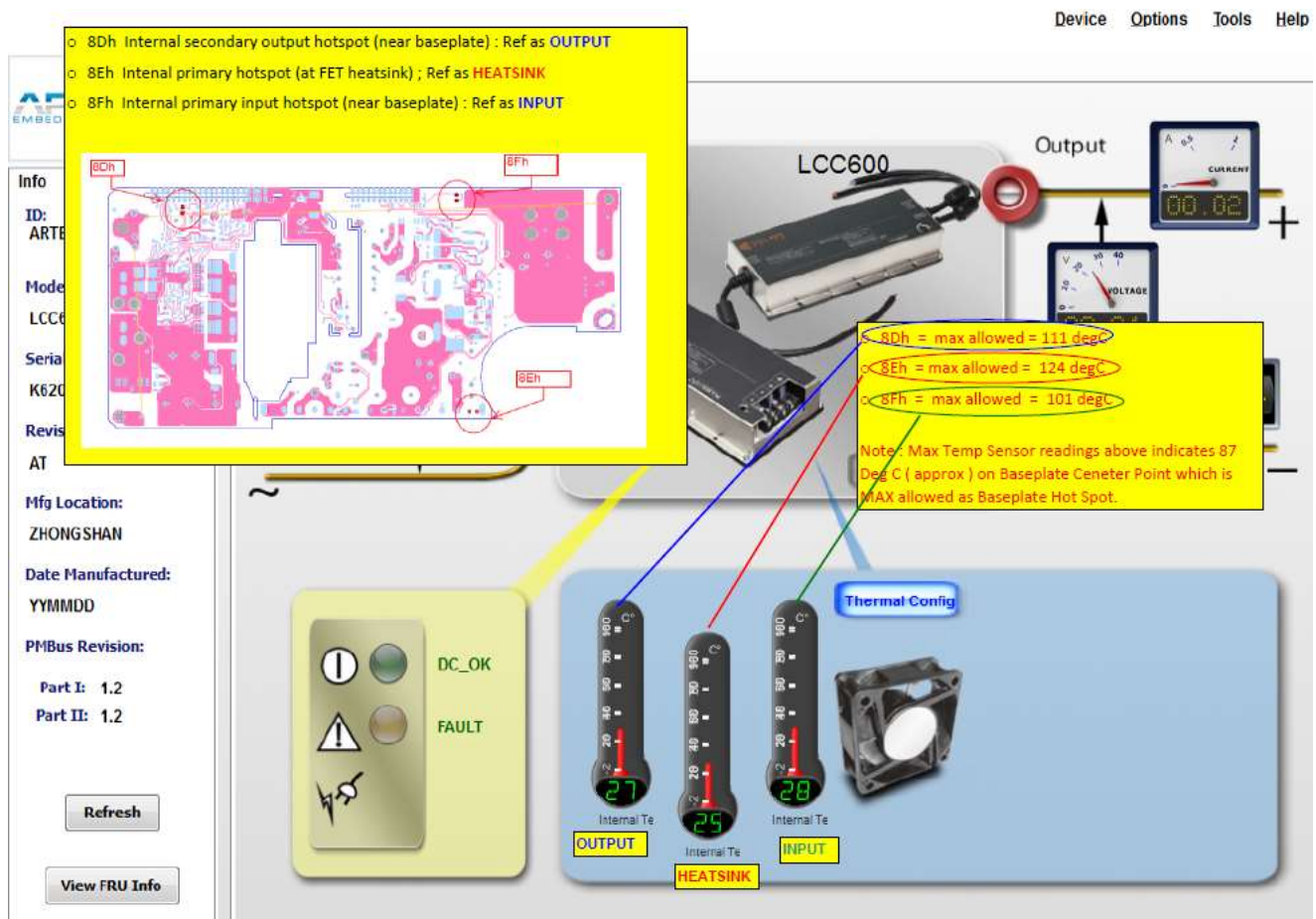

8Dh – Maximum allowed temperature is 111 °C. And cold temperature read out limitation is -10 °C.

8Eh – Maximum allowed temperature is 124 °C. And cold temperature read out limitation is -10 °C.

8Fh – Maximum allowed temperature is 101 °C. And cold temperature read out limitation is -10 °C.

Note - Maximum temperature sensor readings above indicates 87 degC on baseplate center point which is maximum allowed as baseplate hot spot.

APPLICATION NOTES

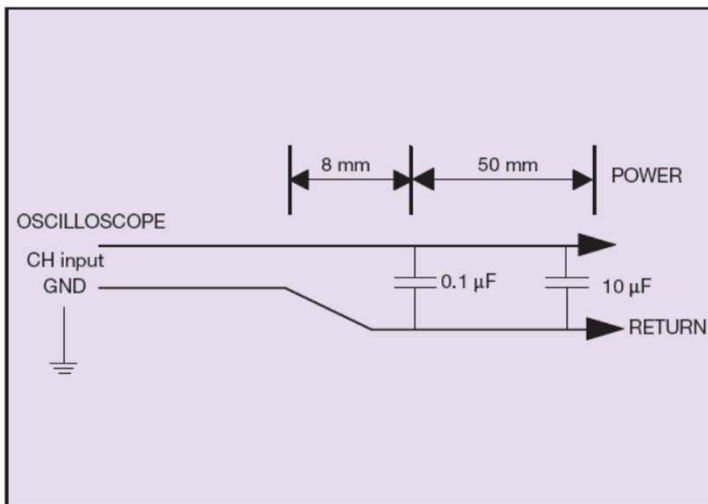

Output Ripple and Noise Measurement

The setup outlined in the diagram below has been used for output voltage ripple and noise measurements on the LCC600 series when measuring output ripple and noise, a scope jack in parallel with a 0.1 μ F ceramic chip capacitor, and a 10 μ F tantalum electrolytic capacitor should be used. Oscilloscope should be set to 20 MHz bandwidth for this measurement.

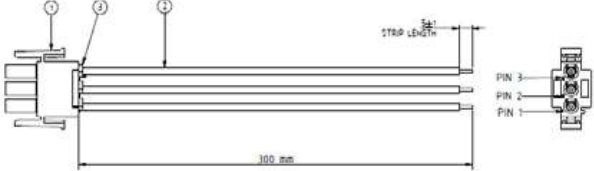
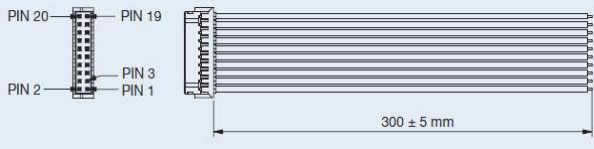
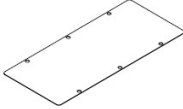

APPLICATION NOTES

Accessories

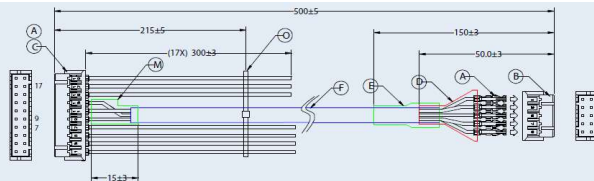
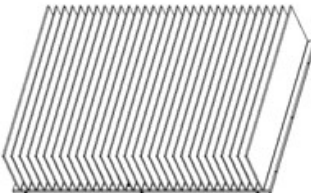
Orderable Part Number	Description	Diagram
70-841-030	For Suffix "-9P" AC Input Mating Connector Cable Assembly (with 0.3 m wire length)	
73-788-001	J1501 (20 Pin Control Signal) Mating Connector with 0.3 m wires attached for "-9P" suffix	
70-841-031	Pre-Cut thermal insulator (Laird TFLEX HR220FG)	
700-014447-0000	MIL-STD-461F AC input In-line EMI filter (Zhongguang ZGLPG-10-02M)	
73-769-002	USB to I ² C High Speed Adaptor for PMBus Communication	
73-769-007	J1501 (20 Pin) Mating connector with 10 Pin header termination for use with 73-769-002	
466-003103-0000	Test Heatsink for unit characterization. Size: 331 x 220 x 69 mm; Aluminum with natural finish; Weight = 1.7 kgs	

RECORD OF REVISION AND CHANGES

Issue	Date	Description	Originators
1.2	07.08.2015	Add WP pin description on page 36, delete the spare pin description, update error in slot ID digits, add SGND in the circuit on page 36, define "S" as send bytes.	K. Wang
1.3	09.10.2015	Add 48V and 28H.	K. Zou
1.4	11.24.2015	Update the command List 40h,42h,43h,44h the default value as 7A00,7200,5600,500A. And update the issue per design comment.	K. Zou
1.5	09.08.2016	Add 12V and 36V and update some issue.	D. Hou
1.6	10.26.2016	Add part number LCC600-28U-9P24. Add Dimming function. And add the Accessories page.	D. Hou
1.7	12.23.2016	Indicate the word "Qualification" besides the "Isolation Voltage" wording in the table indicate the word "Qualification" besides the "Isolation Voltage" wording in the table Update the OTP in table 3	K. Wang
1.8	02.24.2017	Add 'OR-ing FET' on first page.	D. Hou
1.9	04.07.2017	Update the address part A2,A1,A0	K. Wang
2.0	04.27.2017	Update the leakage current	K. Wang
2.1	07.12.2017	Update the leakage current	D. Hou
2.2	08.17.2017	Update the "ISHARE" pin description	D. Hou
2.3	08.24.2017	Add note of 8Dh,8Eh,8Fh cold temperature read out limit -10 °C	D. Hou
2.4	03.23.2018	Add a baseplate temperature location picture in page44	K. Wang
2.5	08.29.2018	Add "LCC600-48U-4PD" in model revision	K. Wang
2.6	12.28.2018	Add "WP pin is only for FRU write protect only"	K. Wang
2.7	01.23.2020	Add 5V standby connected when parallel	K. Wang
2.8	05.21.2020	Remove 28W at 95degC information	K. Wang
2.9	06.19.2020	Update 60950 to 62368	K. Zou
3.0	11.10.2020	Add IEC62368-1 for CB	K. Wang
3.1	04.28.2021	Update INH_EN pin information for parallel application LCC600-48U-4PD adjustment range modify Add CC_PROG Signal description	K. Zou
3.2	06.08.2021	Update P/N list per customer request	K. Wang
3.3	07.15.2021	Correct the 58h from R/W to R	K. Wang
3.4	11.30.2021	Add UKCA Mark	K. Wang
3.5	02.15.2022	Remove repeat OVP spec Add the miss command	K. Wang
3.6	08.16.2022	Update Output Power Derating vs. Input Voltage (305V)	K. Zou
3.7	10.10.2022	Add note for dynamic "Note 1 - Tested with minimum output capacitor of 330uF/A"	K. Wang



For international contact information,
visit advancedenergy.com.

powersales@aei.com (Sales Support)
productsupport.ep@aei.com (Technical Support)
+1 888 412 7832

ABOUT ADVANCED ENERGY

Advanced Energy (AE) has devoted more than three decades to perfecting power for its global customers. AE designs and manufactures highly engineered, precision power conversion, measurement and control solutions for mission-critical applications and processes.

Our products enable customer innovation in complex applications for a wide range of industries including semiconductor equipment, industrial, manufacturing, telecommunications, data center computing, and medical. With deep applications know-how and responsive service and support across the globe, we build collaborative partnerships to meet rapid technological developments, propel growth for our customers, and innovate the future of power.

PRECISION | POWER | PERFORMANCE

Specifications are subject to change without notice. Not responsible for errors or omissions. ©2020 Advanced Energy Industries, Inc. All rights reserved. Advanced Energy®, and AE® are U.S. trademarks of Advanced Energy Industries, Inc.