

# DATASHEETS

THERMALSPECTION 724 | THERMALSPECTION CVM

# THERMALSPECTION 724

Infrared camera system for automated and remote continuous thermal and visual imaging of substations and industrial sites.



The ThermalSpection™ thermal imaging system is designed for continuously monitor the temperature profile of assets within an electrical power substation remotely. It helps detect temperature deviations from normal operation conditions to ensure safe and reliable operations.

The solution includes a substation hardened enclosure with thermal and visual imagers mounted on a pan-tilt positioner. The system can be expanded with optional fixed thermal imagers and fixed single point infrared pyrometers. Combine these items into a unique asset condition monitoring system to remotely control, monitor, trend, archive, and alarm on thermal deviations.

## PRODUCT BENEFITS

- Replace error prone manual inspection process with automated, continuous monitoring using thermal and visual imaging
- Early and remote fault detection and alarm generation
- Monitor newly installed assets or older assets after maintenance to identify risk for infant mortality or faults
- Identify transient thermal events not detectable with manual inspections
- Remotely monitor multiple, distant substations from a central location
- Complete turn-key system with protocols for data export
- All data stored to a database for analysis, remote access, and video playback
- Automated analysis with built-in industry standard analytics

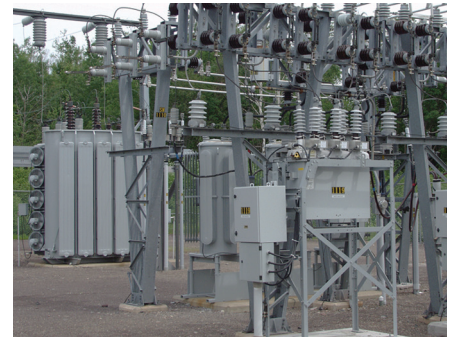

Visual image of substation

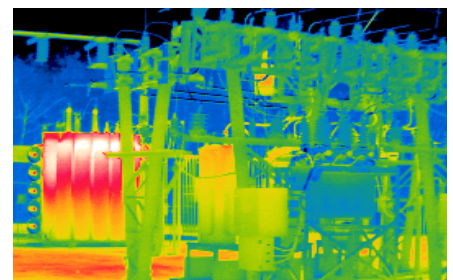

Infrared image of substation

OVERVIEW

The ThermalSpection 724 system allows for continuous monitoring of the temperature profile of assets within an electrical power substation remotely. It helps detect temperature deviations from normal operation conditions to ensure safe and reliable operations.

An overview schematic of the system is shown below. The system consists of thermal and visible cameras mounted on a positioner with continuous 360° pan range and tilt range of ±45°. A junction box with all of the necessary hardware for power and data transfer is also included. This allows for quick access to the camera's thermal readings and configuration options. Fixed image cameras and pyrometers can also be added to the system

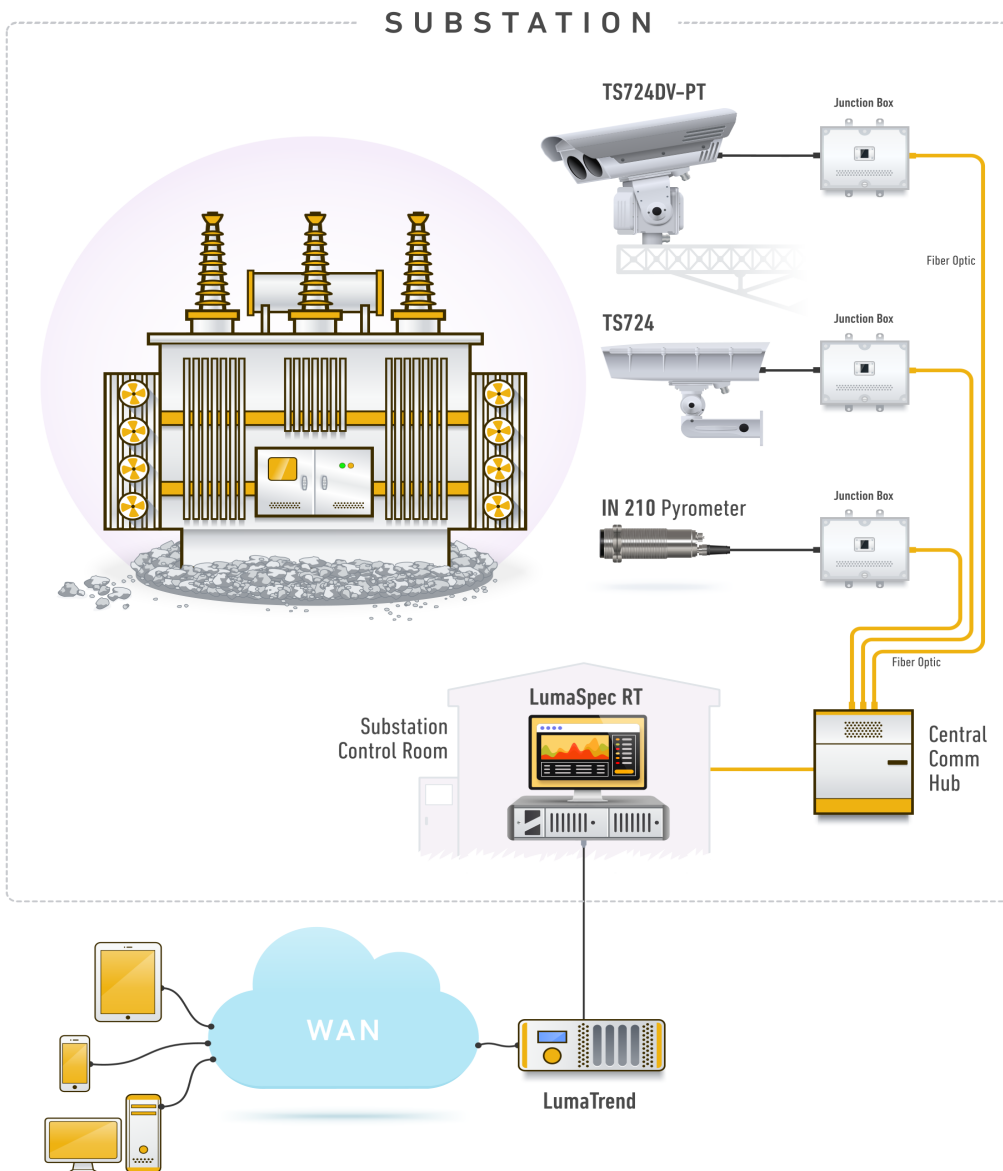

## SYSTEM COMPONENTS

The ThermalSpection system solution includes a substation hardened enclosure with thermal and visual imagers mounted on a pan-tilt positioner. The system can be expanded with optional fixed thermal imagers and fixed single point infrared pyrometers. Combine these items into a unique asset condition monitoring system to remotely control, monitor, trend, archive, and alarm on thermal deviations.

### TS724DV-PT: Pan-Tilt Thermal Imager

The TS724DV-PT includes thermal camera, visual camera, and a pan-tilt positioner that is controlled remotely using LumaSpec RT software. The enclosure protects the cameras from weather and temperature changes and uses a solid state cooling system for reliable, long-term installation. The rugged pan-tilt positioner allows for a 360° continuous rotation on a ±45° tilt axis. Ease of installation is designed into the system with each camera including a stainless steel junction box and a substation hardened 4.5 m (15') umbilical cable to easily connect camera to box. The user only needs to bring power and communications link to the IP66 (NEMA 4X) junction box.



## OPTIONAL COMPONENTS

### TS724: Fixed Mount Thermal Imager

The stationary mount TS724 includes a thermal camera in a weatherized enclosure with adjustable base for mounting. The 640 x 480 resolution thermal camera allows for precise targeting of small objects in a wider field of view. Multiple wide viewing angles (12°, 25°, 42°, and 70°) allow for complete customization for different site layouts and applications



### IN 210: Pyrometer Point Temperature Sensor

The IN 210 is a stationary pyrometer for non-contact temperature measurement of coated metal and non-metallic surfaces between -32°C and 900°C. These pyrometers may be mounted to measure temperatures on objects hidden from view of the TS724DV-PT imagers or fixed mount TS724 imagers.



### Field Imaging Process Controller (FIPC)

The FIPC includes network devices for connecting to the ThermalSpection camera via standard Ethernet connections and computer system for communicating, configuring and processing the camera data. The FIPC also remotely controls the PTU and the automated software features (e.g. Substation Auto Tour). The FIPC should be located in the substation's control room or field cabinet designed to support computer equipment.

### Central Communication Hub (CCH)

The Central Communication Hub (CCH) is a weatherized enclosure and is constructed of stainless steel. It is used to provide a central connection point for the cameras and sensors and mounted in the field to link fiber optics to the controller located in the control house. The CCH offers support for both copper or hardened fiber optic cables for network connections between sensors and the controller.

THERMAL IMAGING SOFTWARE: LUMASPEC RT

LumaSpec™ RT is Windows-based thermal Imaging software that offers high-speed real-time data acquisition and image analysis capabilities. The software enables users to capture images, videos, and data with a thermal imaging camera as well as review and analyze the data with advanced analytical tools.

With LumaSpec RT software, users can use intuitive image and data display tools to understand the thermal characteristics of their processes, equipment, and products using Mikron thermal imaging cameras. Display tools allow users to view thermal snapshots, real time camera feeds, captured sequences, or temperature profiles over larger areas or pinpoint locations.

**Communications Protocols**

LumaSpec RT software supports many standard communication protocols for connection to DCS

including OPC, Modbus, and physical I/Os such as relays and analog outputs. Using these interfaces, users can transfer the alarms and other processed data generated to the plant DCS or to a data historian easily.

**Software Analysis Tools**

Provides users with a vast array of graphing and analysis tools to characterize thermal data over distance, area, and time to thoroughly understand the temperature features of their subject matter. Using LumaSpec RT software analysis tools, users can quickly validate theory, isolate areas of specific interest, or identify uses for monitoring and alerts.

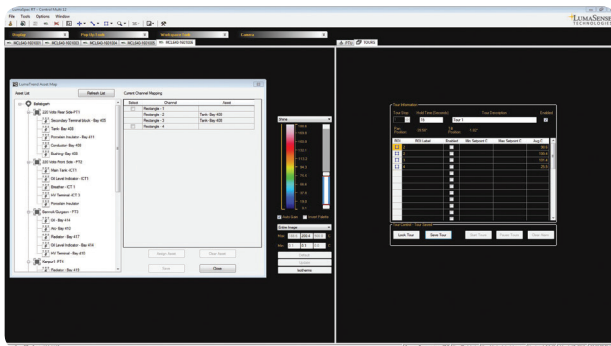

Link the parts measured during the camera's auto-tour to the Asset Tree defined for analysis and reporting in LumaTrend

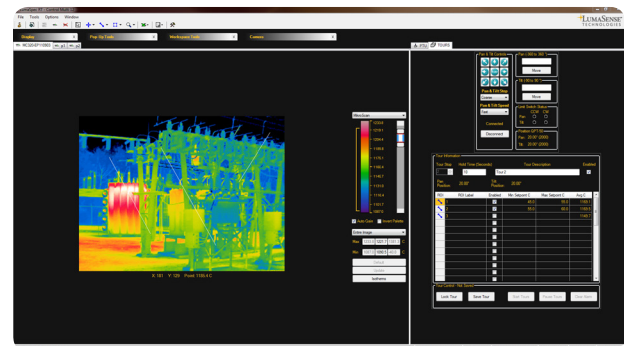

Manage the pan-tilt details and create tours with individual ROI min and max setpoints

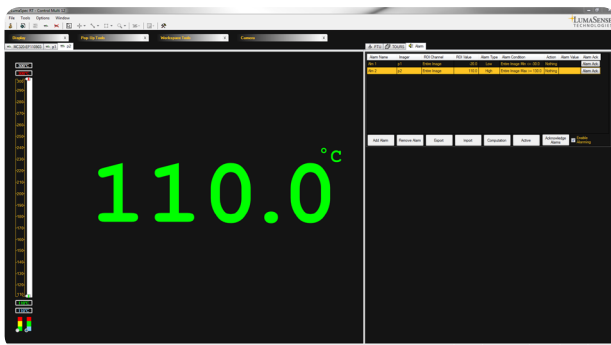

View pyrometer data and readings in the same software as the thermal imaging cameras

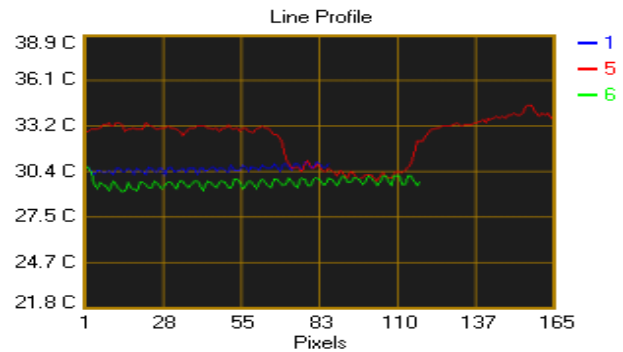

View two dimensional line profile graphs representing the temperature of each pixel along a selected line type ROI

## LUMASPEC RT FEATURES

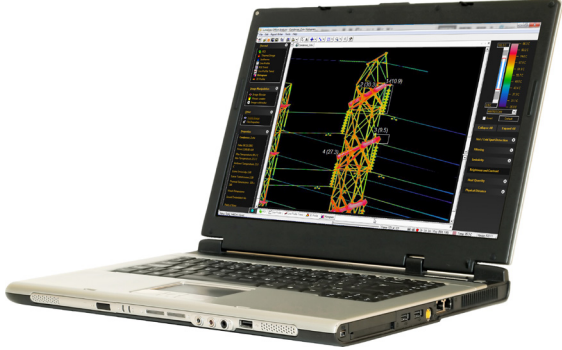
- Simultaneous acquisition from thermal and visual camera, processing, analysis, reporting, and data archiving from multiple systems
  - User-definable tour stops (supports up to 255 tour stops) on each tour stops emissivity, transmission, color palette, focus, NUC, and ROI can be defined (max ROI per tour stop is 32)
  - Image analysis tools: histogram, temperature trend, 3D profile, and line profile
  - Support for different shape ROI including point, lines, rectangles, oval, free line, broken line, polygon, or rotated rectangle
  - Support advanced processing tools including dynamic hot spot detection and Isotherm
  - Alarm and warning generation based on user-defined critical temperature value or temperature range
  - System integration with third party automation devices through OPC and I/O module
  - Digital zoom up to 8x
  - Camera autofocus
- 
- Critical temperature based image archiving with pre-trigger buffer
  - Ability to load site maps in BMP and JPG formats with camera configuration
  - Pan-tilt controls for both automatic and manual positioning
  - Tour controls to save and reproduce specific automated inspection routes

THERMAL IMAGING SOFTWARE: LUMATREND

LumaTrend software complements Advanced Energy's imaging systems by collecting and archiving data from sensors and analyzing that data over time to identify anomalies and provide early detection of problems. It includes a database for long term data storage and reporting and is designed to provide authenticated users access to the data via a web browser interface that is accessible by PC and mobile devices.

**Key Features**

- Archive image data in JPEG format
- Archive temperature data from the pyrometer and generate informative reports
- ROI temperature data stored in the database software
- Generate history temperature trend reports to common formats including PDF and CSV
- LumaTrend is supported on PCs, tablets, and mobile devices (limitations apply)
- Generated temperature trend reports can be emailed automatically based on the user-defined schedule
- Logical tree structure for asset configuration
- Real-time email notification when an alarm or warning is generated. Email includes substation name, system number, tour position name, ROI name, date/time, and alarm temperature
- Generated log files can be emailed automatically based on the user-defined time interval
- Software can be installed on a local server or cloud
- Customizable summary dashboard view

Asset Configuration

Home > Assets > Asset Configuration

Asset List

Search:

Type:  [clear]

+ Add Edit Delete

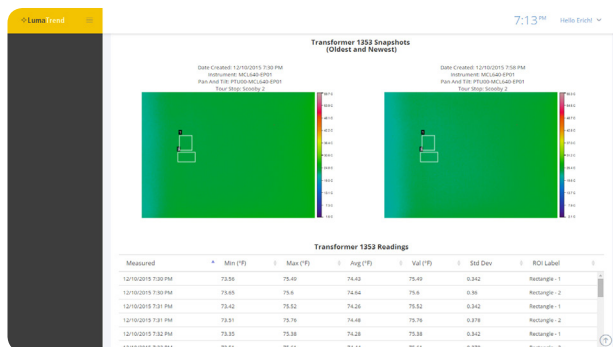
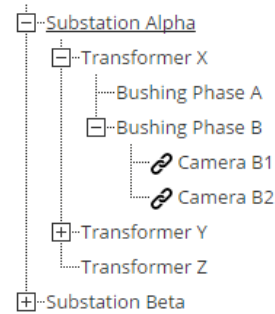

Compare old and new saved images alongside the data

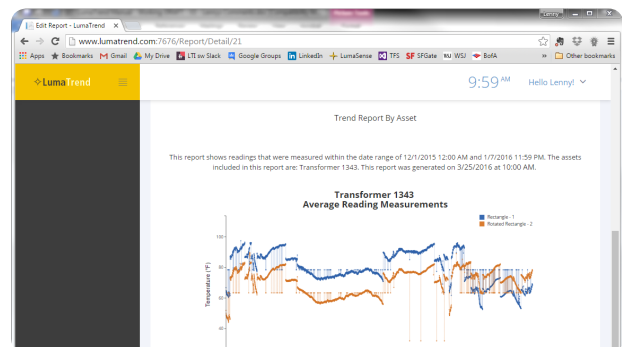

Create custom reports to view trends by individual assets

## MEASUREMENT FIELD AND PIXEL RESOLUTION

Thermal imagers come equipped with optical ranges suitable for most applications. For specific applications, alternative built-in lenses are available. The table and picture (below) show the correlation between the measurement distance, different optics, and the size of the measurement fields.

Distance of Object	Measurement Field (W x H)				
	TS724DV-PT	TS724			
	8° (75 mm) lens	12° (50 mm) lens	25° (25 mm) lens	42° (14 mm) lens	70° (5.3 mm) lens
10 m (32.8')	1.4 m x 1.1 m (4.7' x 3.5')	2.2 m x 1.6 m (7.1' x 5.3')	4.3 m x 3.3 m (14.2' x 10.7')	7.8 m x 5.8 m (25.5 x 19.1')	14 m x 10.5 m (45.7' x 34.3')
25 m (82')	3.6 m x 2.7 m (11.9' x 8.9')	5.4 m x 4.1 m (17.8' x 13.4')	10.9 m x 8.2 m (35.7' x 26.7')	19.4 m x 14.6 m (63.7' x 47.8')	35 m x 26 m (114' x 86')
50 m (164')	7.2 m x 5.4 m (23.8' x 17.8')	10.9 m x 8.2 m (35.7' x 26.7')	21.7 m x 16.3 m (71.3' x 53.5')	38.8 m x 29.1 m (127' x 96')	70 m x 52 m (229' x 172')

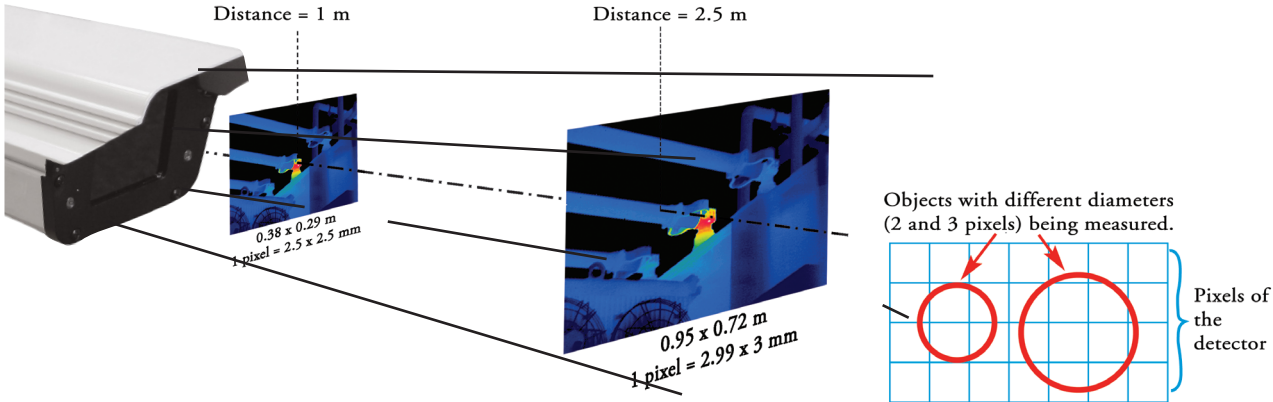

The size of the measured object must be at least 3 x 3 pixels to guarantee precise temperature determination. This ensures that at least one pixel of the detector is completely covered.



TECHNICAL DATA

**Pan-Tilt Positioner Specifications**

Rotation Range	Continuous 360°
Tilt Range	±45°

**Thermal Imaging Camera Specifications**

Temperature Range	-40 to 500°C (-40 to 932°F)
Measurement Accuracy	±2°C or ±2% (whichever is greater)
Resolution	640 x 480 pixels
Field of View	8.2° x 6.2° (75 mm lens)
Infrared Imager	640 x 480 resolution uncooled microbolometer detector
Image Update Rate	Variable depending on operational mode (tour, alarm)
Emissivity Correction	0.1 to 1.0
Background Compensation	Provided
Lens Focal Length	75 mm
Focus	Autofocus
Ambient Temperature	-40 to 60°C (-40 to 140°F) with optional enclosure heater
Storage Temperature	-40 to 75°C (-40 to 167°F)
Weight	26 kg (57 lb)
Communication	Gigabit Ethernet

**Junction Box Specifications**

Material	Stainless steel
Dimensions (W x H x D)	50 cm x 50 cm x 25 cm (20" x 20" x 10")
IP Rating	IP66
Contents	Power supplies, circuit breaker, input protection, both copper and fiber network connections
Cabling	Included, length 4.5 m (15 ft) (to connect to pan-tilt base)
Input Power	220 VDC, 120 VAC, 230 VAC
Network Connection	Fiber: LC connector type, Single mode 1310 nm fiber Copper: RJ45

**Visual Camera Specifications**

Resolution	768 x 576
Minimum Illumination	0.05 lux @ F 1.2
Day and Night Capability	Yes
Communication	Ethernet
Image Sensor	Progressive scan CMOS
Lens	Varifocal IR corrected megapixel resolution

**TECHNICAL DATA (CONTINUED)**

LumaSpec RT Software Specifications	
Number of Cameras	Controls up to 6 at a substation
Database Connectivity	Publishes data and images to LumaTrend or data to 3rd party historian (e.g. Pi) or SCADA via protocols
Operating System	Windows 7, 8, or 10
Auto Measurement	Over 8000 per camera
Cycle Timing	User defined
I/O and Relays	Support to drive local I/O and relays

LumaTrend Software Specifications	
Database	Microsoft SQL
Operating System	Windows Server 2012 R2
User Roles	Administrator, Engineer, and Operator
Deployment	Supports both on-site or cloud deployment
Data Setup	Organized by user defined assets with a logical tree structure
Archiving	Images and temperature data
Reporting Tools	Trends, ROC, and delta Export reports to PDF and CSV
Video Sharing	Historical video playback and movie export
Interface	Browser based and designed for PCs and mobile devices
Alarms/Alerts	Custom setpoints for specific assets
Email Notifications	Based on alarms; scheduled reports

**DIMENSIONS**

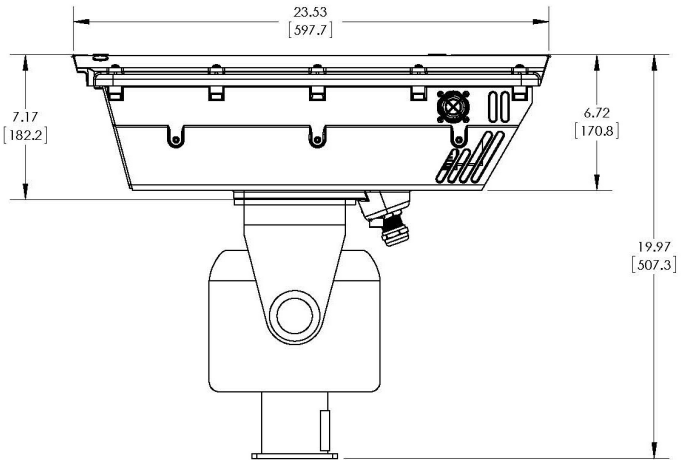
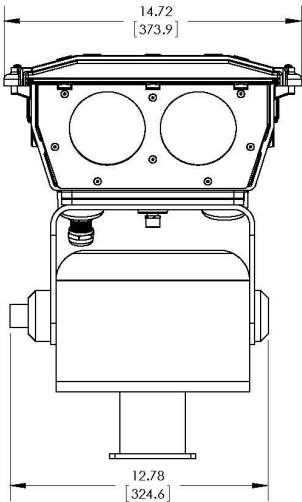

Dimensions in inches [mm]

TECHNICAL DATA - OPTIONAL COMPONENTS

TS724 Fixed Mount High Resolution Thermal Imager Specifications	
Temperature Range	-40 to 500°C (-40 to 932°F)
Measurement Accuracy	±2°C or ±2% (whichever is greater)
Resolution	640 x 480 pixels
Field of View (Horizontal)	12°, 25°, 42°, or 70°
Infrared Imager	640 x 480 resolution uncooled microbolometer detector
Image Update Rate	Variable depending on operational mode
Emissivity Correction	0.1 to 1.0
Background Compensation	Provided
Focus	Fixed
Ambient Temperature	-40 to 60°C (-40 to 140°F) with optional enclosure heater
Storage Temperature	-40 to 75°C (-40 to 167°F)
Weight	~ 7 kg (15.5 lb)
Connectors	Power supply connector and data communication RJ45 connector
Communication	Gigabit Ethernet
Power Input	220 VDC, 120 VAC, 230 VAC

Pyrometer Kit Components	
Pyrometer Type	IN 210
Number of Pyrometers	5
Junction Box	IP66, Stainless steel
Cables from Junction Box to Pyrometer	5 included, 30 m (100') each
Junction Box Dimensions (W x H x D)	50 cm x 50 cm x 25 cm (20" x 20" x 10")
Input Power	220 VDC, 120 VAC, 230 VAC

IN 210 Pyrometer Specifications	
Temperature Range	-32 to 900°C (-25.6 to 1652°F)
Spectral Range	8 to 14 μm
Emissivity ε	0.2 to 1.0 (adjustable)
Response Time t <sub>90</sub>	120 ms (adjustable)
Accuracy (ε = 1, T <sub>amb</sub> = 25°C, t <sub>90</sub> = 1 s)	1% of reading in °C + 1 °C
Repeatability (ε = 1, T <sub>amb</sub> = 25°C, t <sub>90</sub> = 1 s)	0.5% of reading in °C + 1 °C
Aperture	15 mm
Ambient Temperature	0 to 70°C (32 to 158°F)
Storage Temperature	-20 to 70°C (-4 to 158°F)
Protection Class	IP 65 (DIN 40 050)
Weight	Approx. 450 g (0.99 lb)
XE Λαβελ	According to EU directives about electromagnetic immunity

## TECHNICAL DATA - OPTIONAL COMPONENTS (CONTINUED)

Field Imaging Process Controller (FIPC) Specifications	
Form Factor	19" rack mount, 2U chassis, 524 mm deep
	Front-accessible USB, system fan, and hard drives
Data Storage and Memory	Shock-resistant hot-swap hard disk drives
	1T hard drives with RAID (Qty: 2)
	Integrated optical disk drive
Industrial Grade	Redundant power supplies
	Intelligent fan control and air filter
	10G operating shock
Operating Temperature	0 to 40°C (32 to 104°F)
Storage Temperature	-40 to 70°C (-40 to 158°F)

Central Communications Hub (CCH) Specifications	
Dimensions (W x H x D)	50 cm x 50 cm x 25 cm (20" x 20" x 10")
Material	Stainless steel
IP Rating	IP66
Ports	4 fiber ports and 4 copper ports
Input Power	220 VDC, 120 VAC, 230 VAC



For international contact information,  
visit [advancedenergy.com](http://advancedenergy.com).

[sales.support@aei.com](mailto:sales.support@aei.com)  
+1 970 221 0108

## ABOUT ADVANCED ENERGY

Advanced Energy (AE) has devoted more than three decades to perfecting power for its global customers. AE designs and manufactures highly engineered, precision power conversion, measurement and control solutions for mission-critical applications and processes.

AE's power solutions enable customer innovation in complex semiconductor and industrial thin film plasma manufacturing processes, demanding high and low voltage applications, and temperature-critical thermal processes.

With deep applications know-how and responsive service and support across the globe, AE builds collaborative partnerships to meet rapid technological developments, propel growth for its customers and power the future of technology.

PRECISION | POWER | PERFORMANCE

---

Specifications are subject to change without notice. Not responsible for errors or omissions. ©2019 Advanced Energy Industries, Inc. All rights reserved. Advanced Energy®, FurnaceSpection™, LumaSpec™, and AE® are U.S. trademarks of Advanced Energy Industries, Inc.

# THERMALSPECTION CVM

Real-time thermal imaging solution for fault detection and monitoring for critical vessels such as gasifier skin temperature.



Critical vessels in the chemicals, refining, and power industries operate at high temperature and pressure and are at risk of failure as joints and refractory degrade. The consequences of undetected failures can be very serious.

Conventional methods of real-time monitoring are unreliable and expensive to install and operate. Advanced Energy's ThermalSpection™ CVM infrared imaging system offers real-time, continuous fault and hot-spot monitoring, allowing plant operators to identify problems before they become emergencies. The system offers a turn-key solution for monitoring critical vessels, such as gasifier skin temperature.

## PRODUCT HIGHLIGHTS

- Early fault detection reduces risk, emergencies, and unplanned outages
- Continuous, automated monitoring
- Integrates into existing plant control system and data historian archive
- Designed for hazardous area installations (ATEX and Class I, Div 2)
- Proven technology from the world leader, with installations in the US, Canada, Europe, and Asia



Gasifier without thermal imaging

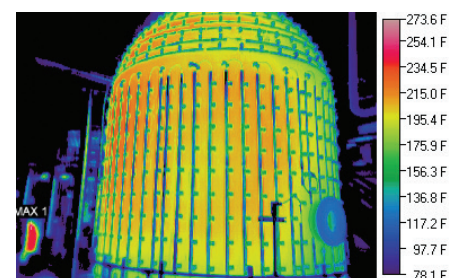

Gasifier thermal imaging screenshot

TECHNICAL DATA

MCL640 Infrared Camera Specifications	
Detector	640 x 480 uncooled focal plane array (microbolometer)
Temperature and Spectral Range	-40 to 120°C (-40 to 248°F) and 0 to 500°C (32 to 932°F) High temperature option available
Measurement Accuracy	±2% oR or 2°C
Field of View (H x V)	14° x 10°, 26° x 20°, 57° X 43°, 77° x 58°
Focus Range	Lens dependent. See website.
Pixel Pitch	17 µm
Image Update Rate	9 Hz or 50 Hz
Emissivity Correction	0.1 to 1.0
Transmittance	0.1 to 1.0
A/D Resolution	16 bit

Physical Characteristics	
Lens Focal Length (H x L x W)	175 mm x 772 mm x 207 mm (6.89" x 30.39" x 8.15")
Weight	Approximately 11 kg (25 lb)

Interface and Electrical Specifications	
Communication	Gigabit Ethernet
Power Supply	Universal AC input standard (DC optional)

Environmental Specifications	
Operating Temperature	0 to 60°C (32 to 140°F) With optional heater: -40 to 60°C (-40 to 140°F)
Storage Temperature	-20 to 70°C (-4 to 158°F)
Housing (ATEX and Class I, Div 2)	Includes IR transparent window, interface connections, power termination strip, vortex air cooler with thermostat control or optional heater with thermostat control

Online Thermal Imaging Software	
Presentation	In run mode, the screen displays a live thermal image in 256 colors. Images can also be frozen.
Remote Camera Control Functionality	Select the camera type, mode, range, temperature scale and lens. Also allows adjustments to be made for focusing, emissivity, ambient calibration, and percentage of transmission loss.
Real-Time Image and Data Acquisition	Large amounts of data can be captured at a user-adjustable rate.
Multiple Regions of Interest (ROIs)	Process and compute the minimum, maximum, and average temperatures for up to 32 Regions of Interest defined in a variety of shapes.
Multiple Color Palettes	Flexibility for optimal image clarity.
Offline Analysis	Replay and analyze image sequence files that have been previously captured and saved to disk.

**Compact Remote Input/Output Modules**

- Relay Output (Alarms) Module: 6-channel digital input module with each channel ranging from 30 VDC to 120 VAC
- Power Relay Module: 6-channel digital input module with each channel ranging from 30 VDC to 250 VAC
- 0 to 20 mA, 4 to 20 mA Universal I/O Module Module: 12-channel universal input/output module with 6 analog inputs, 2 analog outputs, 2 digital inputs, and 2 digital outputs. Allows LumaSpec RT software to send each ROI temperature to an output.

## OVERVIEW

**System Options**

The ThermalSpection system has several optional components, allowing you to customize a solution for your specific needs:

- Analog outputs
- Auxiliary pyrometer sensors integrated into the system to measure critical areas or tight locations that are obstructed from view (blind spots) to the thermal imaging camera
- Remote controlled pan and tilt mechanism for automated and remote aiming of the camera

**Easy Integration Into the Plant's DCS**

The ThermalSpection system is fully digital and uses standard Ethernet LAN. This allows easy and cost-effective transfer of digital image data to control rooms. Additionally, the LumaSpec™ software has modules that support output via Modbus or OPC to the plant's DCS.

**Designed for Hazardous Environments**

Each thermal imaging camera is mounted in a sealed housing that includes internal cooling and a positive pressure purge to prevent dirt or flammable gases from entering the enclosure. Each camera has an Internet IP address and password protection, allowing control from any computer in the network. All field hardware is protected by ATEX or Class I, Div 2 certified housings.



The ThermalSpection in its protective enclosure. Power, communication, and air connections are contained in a single hose.

## SOFTWARE WITH AUTOMATED ANALYSIS

Advanced Energy's LumaSpec software provides advanced features in a user-friendly interface. From a single computer, the software can send commands to and gather data from up to 24 cameras mounted in the field. Thermal data can be captured in snapshot frames at set intervals, or capture can be triggered by temperature alarms connected to user-defined Regions of Interest (ROIs).

- Auto "Hot Spot" Tracking Feature
- HTML displays for broadcast on plant intranet
- Rate of change temperature charts
- Data Historian Archive
- Integrates with Plant's DCS
- OPC/Modbus interface supported
- Optional integration with third party PI database systems

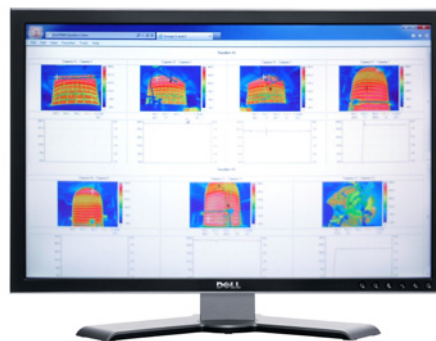



## THERMALSPECTION CVM SYSTEM MONITORING A GASIFIER

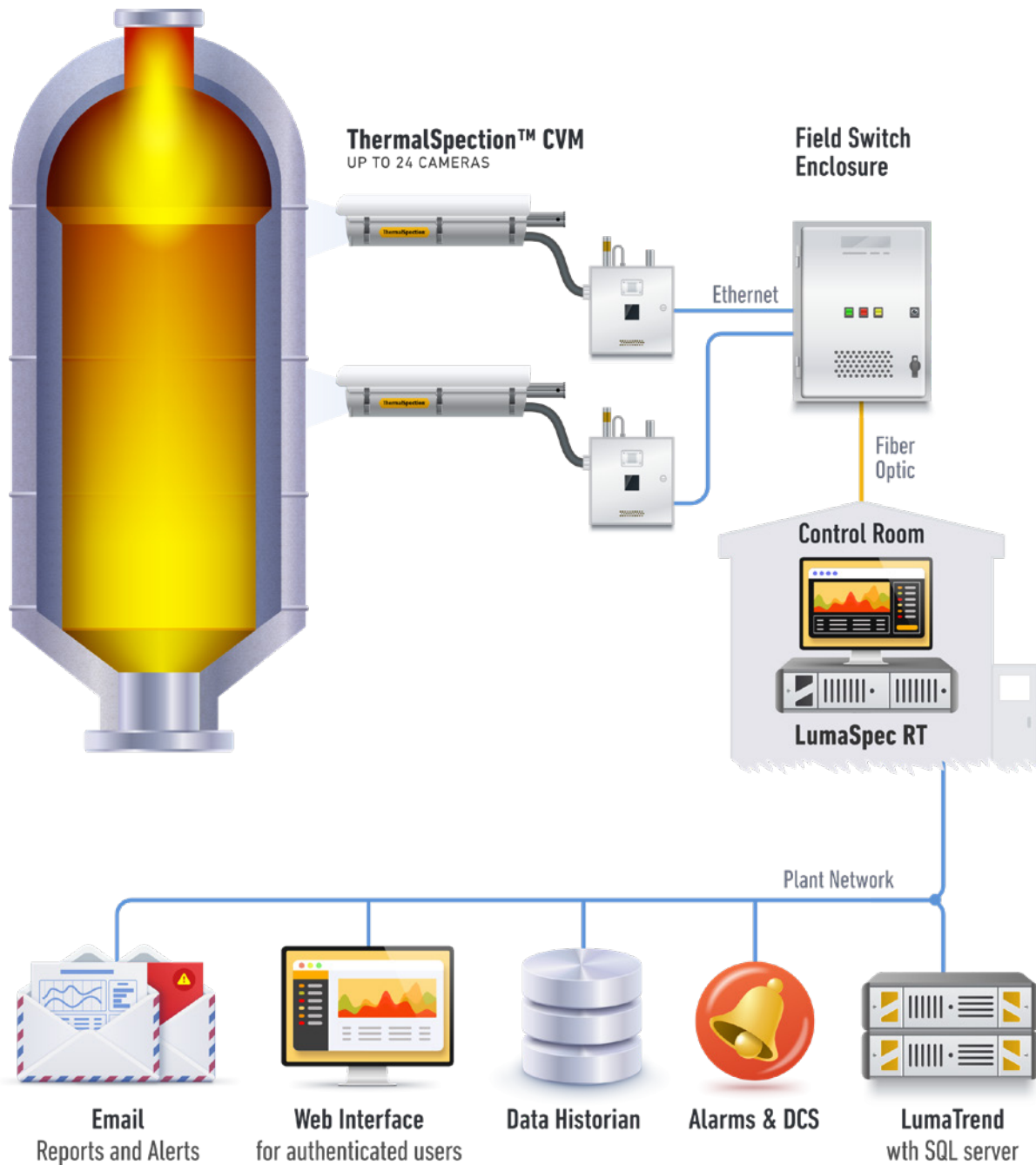

For international contact information, visit [advancedenergy.com](http://advancedenergy.com).

[sales.support@aei.com](mailto:sales.support@aei.com)  
+1 970 221 0108

PRECISION | POWER | PERFORMANCE

Specifications are subject to change without notice. Not responsible for errors or omissions. ©2019 Advanced Energy Industries, Inc. All rights reserved. Advanced Energy®, ThermalSpec™, LumaSpec™, and AE® are U.S. trademarks of Advanced Energy Industries, Inc.